

SAFE-1000N | SAFE1800

DVR USER MANUAL

Ver 2.8.5

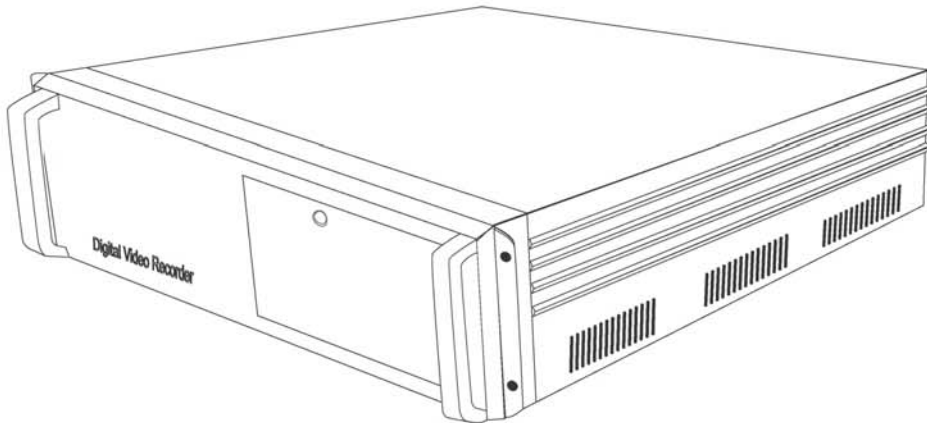

 **SAFELAND**

TABLE OF CONTENTS

SECTION	PAGE
1.1 PROGRAM START.....	1
1.2 PROGRAM EXIT.....	1
1.3 SHUT DOWN.....	1
1.4 SHELL MODE.....	2
1.5 EZ UPDATE.....	4
2.1 SETUP SCREEN.....	7
2.2 SETUP MENU BAR.....	8
2.3 CAMERA SETUP.....	9
2.4 RECORD SPEED SETUP.....	10
2.5 RECORD SCHEDULE SETUP.....	11
2.6 MOTION SETUP.....	12
2.7 AV MONITOR.....	13
2.8 SENSOR & ALARM SETUP.....	14
2.9 AUDIO SETUP.....	15
2.10 ACCOUNT SETUP.....	16
2.11 NETWORK SETUP.....	17
2.12 DIET MODE SETUP.....	19
2.13 ETC SETUP.....	21
2.14 SOFT KEYBOARD.....	23
2.15 CONFIRM & CANCEL.....	24
3.1 INTRODUCTION TO SURVEILLANCE.....	25
3.2 RECORDING STATUS.....	26
3.3 SAFE-DVR INFORMATION WINDOW.....	26
3.4 EVENT & LOG HISTORY WINDOW.....	26
3.5 CONNECTED USER STATUS.....	28
4.1 SEARCH SCREEN FORMATION.....	29
4.2 PLAY CONTROLS.....	29
4.3 VIDEO SEARCH.....	30
4.4 AUDIO PLAY.....	30
4.5 IMAGE Backup(FDD Backup).....	30
4.6 IMAGE PRINT.....	30
5.1 INTRODUCTION TO MULTI-SEARCH.....	31
5.2 MULTI - SEARCH.....	31
5.3 ENLARGE MODE.....	32
5.4 BOOKMARK.....	33

6.1 INTRODUCTION TO PANORAMA SEARCH	34
6.2 IMAGE PRINT.....	35
6.3 PANORAMA ENLARGED-SCREEN	36
6.4 IMAGE ADJUSTMENT	37
6.5 SMART SEARCH.....	38
7.1 INTRODUCTION TO BACKUP.....	39
7.2 BACKUP SELECTED FILE.....	40
7.3 BACKUP BY TIME.....	41
7.4 FILE SAVING STRUCTURE OF SAFE-DVR FOR BACKUP	42
8.1 OPEN PROTOCOL.....	43
8.2 STARTING OPEN PROTOCOL.....	43
8.3 OPEN PROTOCOL SETUP.....	43
8.4 OPEN PROTOCOL EXAMPLE	44
8.5 HEXADEMICAL NUMERIC SYSTEM	46
9.1 SAFE-DVR WEB WERVICE.....	47
9.2 WEB VIEWER	47
10.1 TCP / IP filtering.....	49
10.2 TCP/IP setup for 'TCP/IP filtering'	49

1.1 PROGRAM START

After installing the SAFE-DVR program, it will automatically run after rebooting the system. The program will be registered on the 'START UP' program and 'Desktop'.

1.2 PROGRAM EXIT

When exiting the program, please exit by pressing the **[Exit]** button.

You will exit to the Windows 2000 desktop.

1	Press [Exit] button on the Monitoring Screen.	
2	Select [Admin] on the [USER ID] and then enter its [PASSWORD] . (The default Password is '1') Then press [OK] and the program will be closed.	



1.3 SHUT DOWN

Any improper shutting down may occur system trouble. Please follow these steps to shut down the SAFE-DVR system completely and safely.

1	<p>After exiting the SAFE-DVR program, press [Shutdown] icon. At the shutdown dialog box, select [Shutdown] and press the [OK] button.</p> 
2	<p>Within a minute, the system will be completely shut down.</p>

1.4 SHELL MODE

SAFE-DVR provides the shell mode that provides compulsory functions of Windows to keep a SAFE-DVR only as a surveillance device. With the shell mode, user cannot operate a program or access to the internet which may interrupt the proper operation of a SAFE-DVR.

DVR Shell functions are as below.

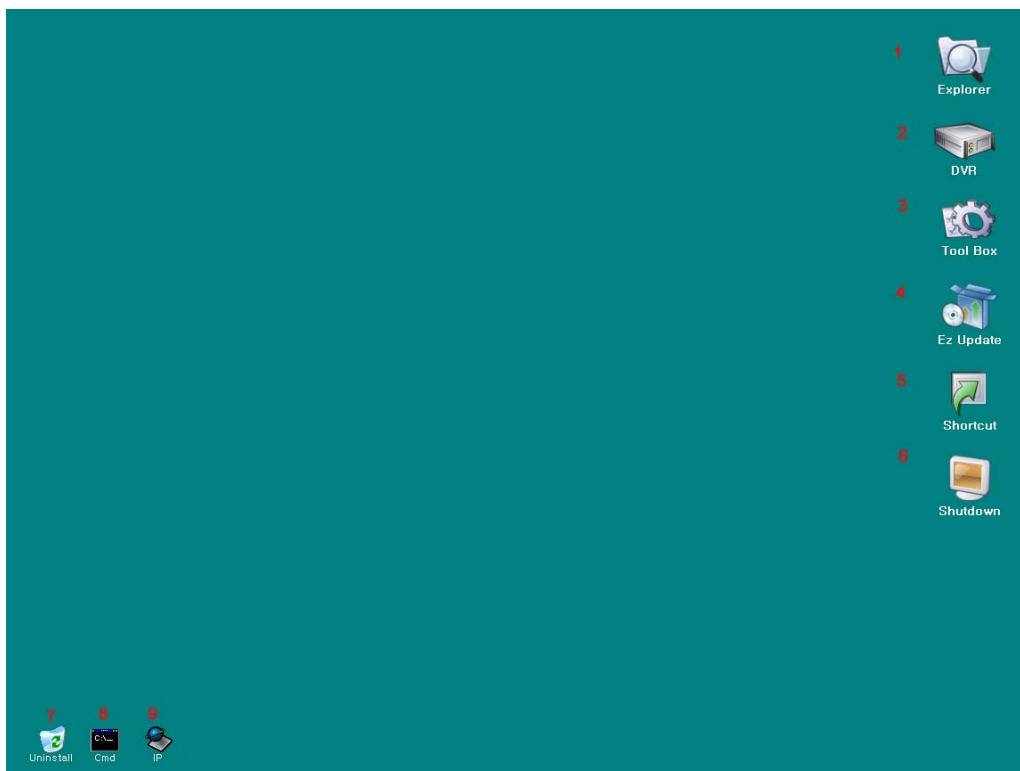

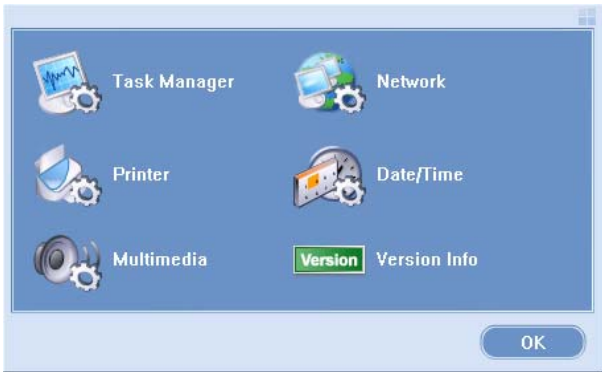
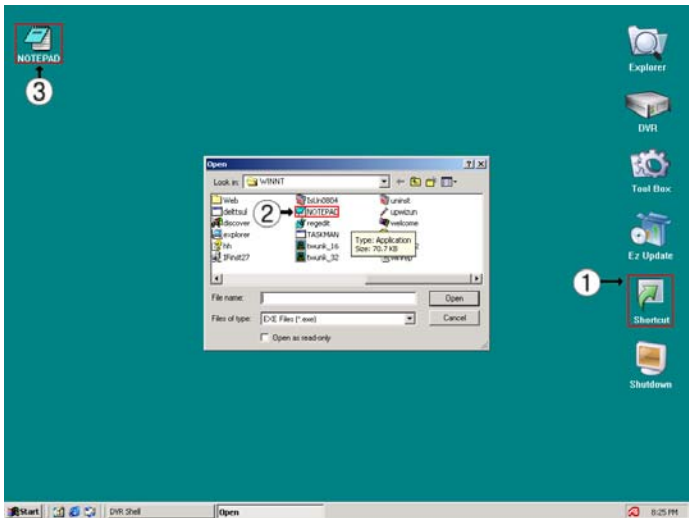
1	Open the Windows Explorer.
2	Start the SAFE-DVR program.
3	<p>When user starts the [Tool Box], below window will appear.</p> <p>In [Tool box], user can</p> <ol style="list-style-type: none"> 1. see working programs through 'Task Manager'. 2. make/modify the network information of a SAFE-DVR including IP through 'Network'. 3. set a print after installing it through 'Printer'. 4. set time/date for the recorded images and the search for them through 'Date/Time'. 5. set multimedia stuff including a sound card through 'Multimedia'. 6. see the version of the SAFE-DVR through 'Version Info'. 
4	<p>User can update the SAFE-DVR program through the appointed server.</p> <p>For further information, please refer to '1.5. EZ update'.</p>
5	<p>User can make a shortcut icon for a program with 'Shortcut' function.</p>  <p>Double-click the shortcut icon to open the file explorer.</p> <p>Choose the file and press [Open] button.</p> <p>The shortcut icon that user chose made on the left-top of the DVR Shell screen.</p>

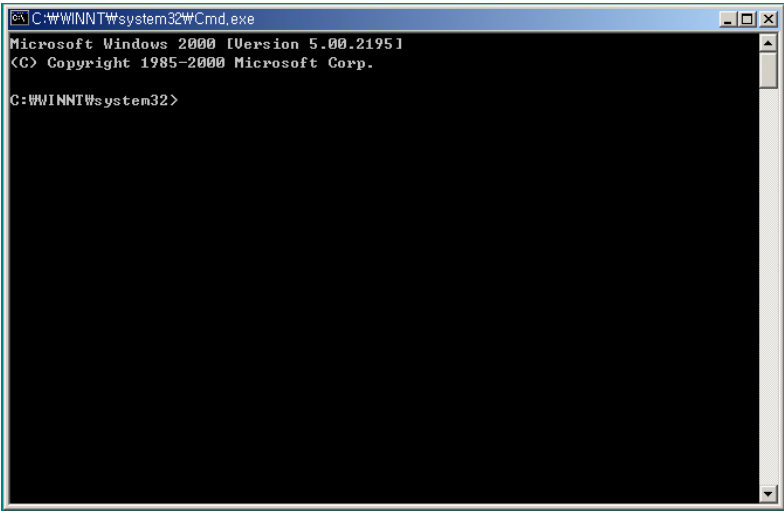
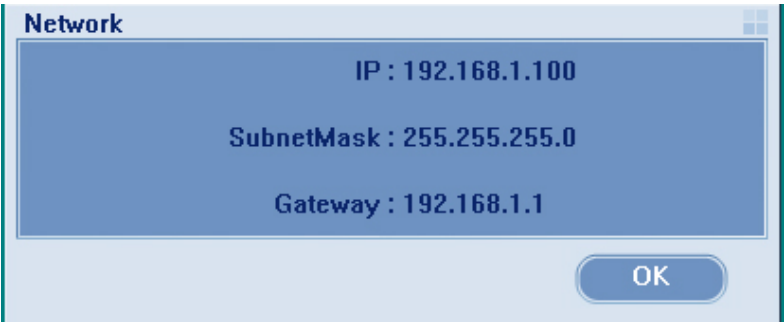
	To remove the icon, click the icon and press [Delete] key on a keyboard.
6	Finish/Restart the system.
7	Uninstall the program.
8	<p>Command window</p> 
9	<p>User can check the IP.</p> 

1.5 EZ UPDATE

EZ update keeps you have the most newly updated SAFE-DVR program. User should operate 'EZ update' sometimes because it doesn't work itself.

Please refer to below to use 'EZ update'.

1	<p>Double click the EZ update icon.</p>  <p>Ez Update</p>
---	--

Below window will appear.

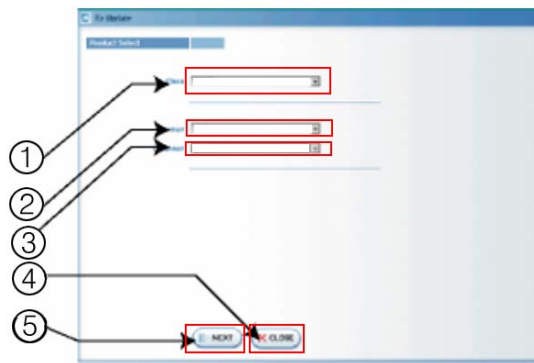

2	A	Class	Server administrator can appoint classes. For example, If you are operating a communication server (CS), you must select SVNS class.
	B	Product	Select a model among 1000, 1800, 2000, 2200, 4000 and 4200. For more information on the version or the model, please refer to the tool box.
	C	Language	Select a language.
	D	Close	Stop updating and close the window.
	E	Next	Finish the selection and go to the next window.

3

Updated contents are shown. Press [UPDATE] button to process the update and [BACK] button to go back to previous window.

4

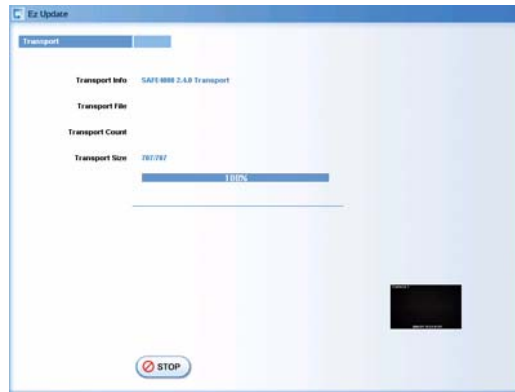

Update is proceeding.

5

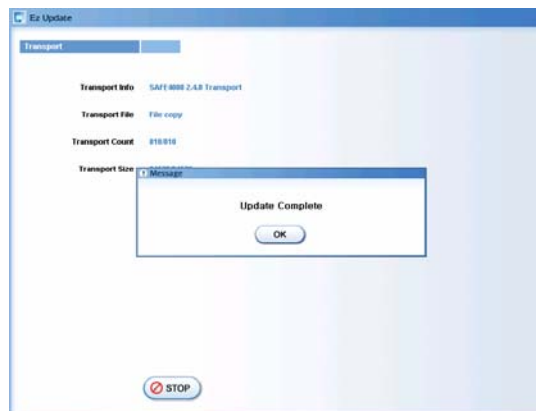

Update is completed. Press [OK] button to finish the update process. When you start the SAFE-DVR afterward, the updated information will be automatically applied.

* EZ Update server is not registered at first.

Please contact to a selling agency when you need an update through EZ Update server.

2.1 SETUP SCREEN



[Login Screen]

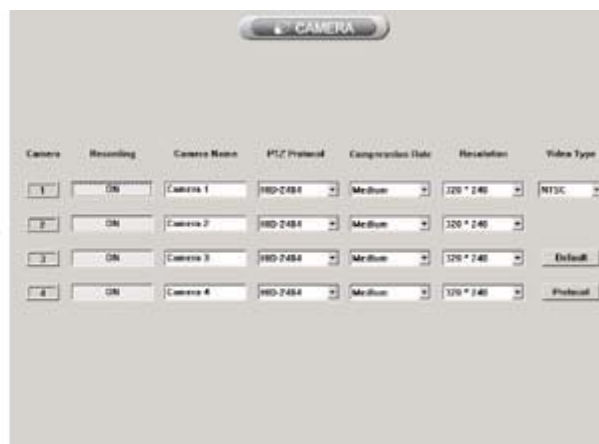

[Setup Screen]

1	Press [Setup] button on the Monitoring Screen. The Login Window will appear.	
2	Select [Admin] on the [User Name] box and enter the password. (The default password is '1') Then press [OK] button. The Setup Screen will appear.	

NOTE: You can only select the [User Name] by clicking the dropdown menu not by typing.

2.2 SETUP MENU BAR

The setup menu bar consists of 11 setting buttons, a cancel button and a confirm button.

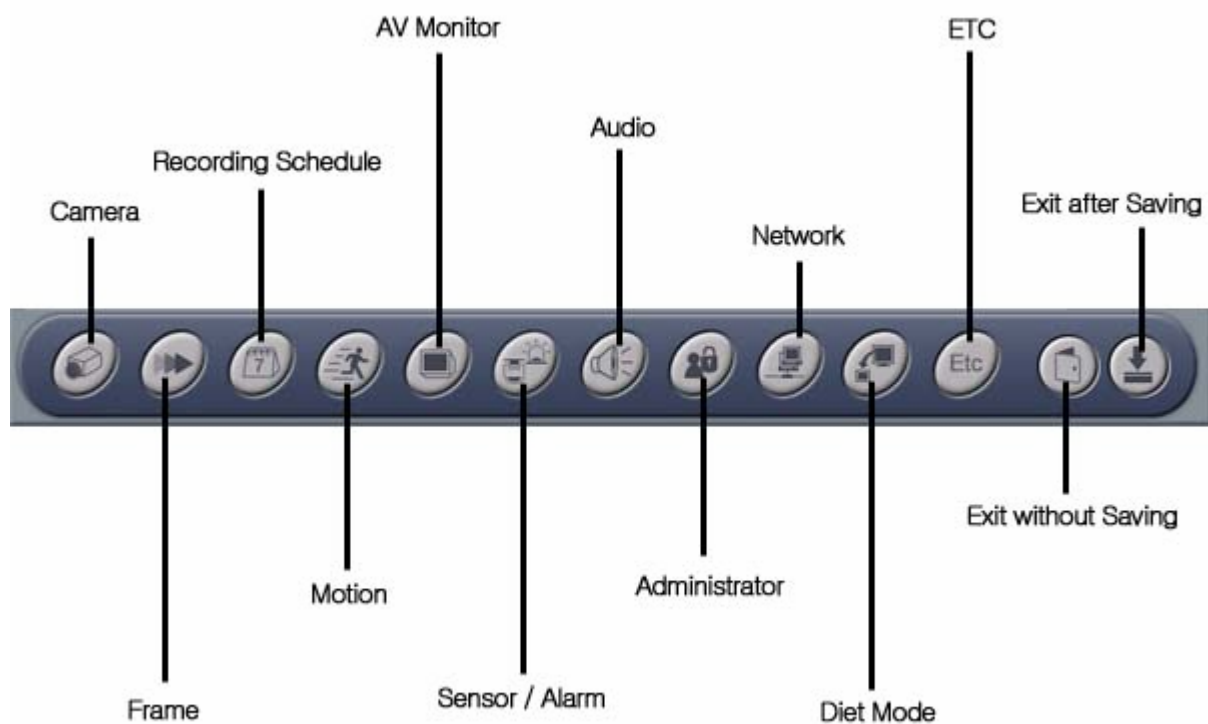

2.3 CAMERA SETUP

The Camera Settings are as following.

The screenshot shows the 'CAMERA' configuration page. At the top, there is a 'CAMERA' button and a 'Select input video signal (NTSC or PAL)' dropdown. Below this is a table with columns: Camera, Recording, Screen Visible, Camera Name, PTZ Protocol, Compression, Resolution, and Video Type. The table contains four rows for Camera 1 through Camera 4. Callouts provide additional information: 'Set each camera's Recording by ON/OFF option.' points to the Recording column; 'Visible or Invisible option for surveillance screen' points to the Screen Visible column; 'Set Rx-Driver of PTZ camera (Each camera can have different Rx-Driver.)' points to the PTZ Protocol column; 'Set each camera's name (up to 10 characters)' points to the Camera Name column; 'Set compression rate for recording High compression rate means small file size.' points to the Compression column; 'Set resolution for Recording' points to the Resolution column; 'Initialize all of the settings' points to the 'Default' button; and 'User can create a PTZ protocol which doesn't exist on the Rx-Driver list.' points to the 'Protocol' button.

Camera	Recording	Screen Visible	Camera Name	PTZ Protocol	Compression	Resolution	Video Type
1	ON	Visible	Camera 1	HID-2404	Medium	320 * 240	NTSC
2	ON	Invisible	Camera 2	HID-2404	Medium	320 * 240	
3	ON	Visible	Camera 3	HID-2404	Medium	320 * 240	Default
4	ON	Visible	Camera 4	HID-2404	Medium	320 * 240	Protocol

Tip!

1. In case of [Recording] option, left click of the character "Recording" after changing just one camera setting drives the change of all camera setting. It is very convenient option when user wants to apply the change to all cameras.
2. Resolution cannot be applied to each camera separately.
3. Administrator can hide some screens in surveillance mode by the "Screen Visible" option. It will be useful to exposure-prohibited area such as Sauna.

2.4 RECORD SPEED SETUP

Set the recording schedules in this menu.

The screenshot shows the 'RECORD SPEED' configuration window. At the top, there are three dropdown menus for 'Capture' (30), 'Recording' (30), and 'Network' (25). Below these are three buttons: 'Apply in a lump', 'Apply to all cameras', and 'Default'. A 'Rec' dropdown is set to 'Always'. The 'Setting State' section contains a table with columns for Camera, Capture, Recording, and Network. Below the table is a 'Rec. Time' section with dropdowns for 'Always' (5), 'Min.', 'Motion' (10), 'Sec.', and 'Sensor' (10) 'Sec.'. Callouts provide detailed instructions for each element.

Setting State

Camera	Capture	Recording	Network
1	30	30	
2	30	30	
3	30	30	25
		30	25

Rec. Time

Always 5 Min. Motion 10 Sec. Sensor 10 Sec.

Tip!

1. Capture frame : The number of frames when DVR card captures input signal from a camera. So, Recording or Network frames will be always set less than capture frames.
2. Recording frame : The number of frames for DVR recording.
3. Network frame : The number of transported real-time frames for remote surveillance.
4. The maximum values are 30 frames per second for one channel so that SAFE1800 will support 120 frames per second(4 channels).
5. The default value of network frame is 25 frames/sec because 25 frames/sec is the most suitable condition for surveillance from remote site.
6. Continuous recording time means the length of recording time of one avi file.

2.5 RECORD SCHEDULE SETUP

Set the recording schedules for each camera in this menu.

The screenshot displays the 'SCHEDULE' configuration window. At the top, there are camera selection buttons labeled 'Camera 1', '2', '3', and '4'. A callout bubble points to these buttons with the text: '1. Select camera(s) for setting recording schedule.' To the right, a 'Dragged Time' box shows '12:50 ~ 19:20'. Below the camera buttons is a grid with columns for days of the week (Sun, Mon, Tue, Wed, Thu, Fri, Sat) and rows for hours from 00:00 to 24:00. A callout bubble points to the grid with the text: '3. Drag on the board to set recording schedule. Multi-scheduling is possible.' On the right side of the grid, there are recording mode buttons: 'Continuous' (red), 'Motion' (blue), 'Sensor' (green), and 'Erase' (grey). A callout bubble points to these buttons with the text: '2. Select recording mode.' Below the mode buttons are application buttons: 'All Cameras', 'All Days', and 'Default'. A callout bubble points to these buttons with the text: 'Identically apply the schedule to all cameras.' Another callout bubble points to the 'All Days' button with the text: 'Identically apply the schedule to all days'.

Tip!

1. You can select some cameras at the same time by clicking camera button with pushing [Ctrl] key on your keyboard. Settings will be identically applied to the selected cameras.
2. Clicking day button(Sun/Mon/Tue/Wed/Thu/Fri/Sat) after selecting recording mode will take you to apply to the whole day.

2.6 MOTION SETUP

Set the motion detection and sensitivity of each camera. User can also set the brightness and contrast of the camera.

The screenshot displays the MOTION setup interface, which is divided into several sections:

- MOTION Header:** A button with a person icon and the text "MOTION".
- Setting Zone:**
 - Buttons for "All" (Set the whole screen as a motion area), "Clear" (Undo the latest area), "Zone" (Partially set maximum 5 motion areas), and "Undo" (Undo all areas).
 - A "Sensitivity" dropdown menu set to "7" (Motion sensitivity: Low number indicates high sensitivity) and an "Apply All" button (Apply motion sensitivity to all cameras identically).
 - "Default All" and "Default" buttons.
- Adjust Screen:**
 - Sliders for "Bright" and "Contrast", both ranging from -30 to +30, with a "0" dropdown menu.
 - "Default", "Default All", and "Apply All" buttons.
- Visual Feedback:** A central window shows a camera feed with the "SAFELAND" logo and a red motion-detection area.

Callouts provide additional instructions:

- "Set the whole screen as a motion area." points to the "All" button.
- "Partially set maximum 5 motion areas" points to the "Zone" button.
- "Motion sensitivity (Low number indicates high sensitivity.)" points to the "Sensitivity" dropdown.
- "Undo the latest area." points to the "Clear" button.
- "Undo all areas." points to the "Undo" button.
- "Apply motion sensitivity to all cameras identically." points to the "Apply All" button.
- "Set motion areas by mouse-dragging on the screen." points to the camera feed area.
- "Set brightness and contrast for each camera." points to the "Bright" and "Contrast" sliders.
- "Apply brightness and contrast to all cameras identically." points to the "Apply All" button in the Adjust Screen section.

2.7 AV MONITOR

Set rotation option and display camera on AV monitor when especially using out monitor instead of PC monitor.

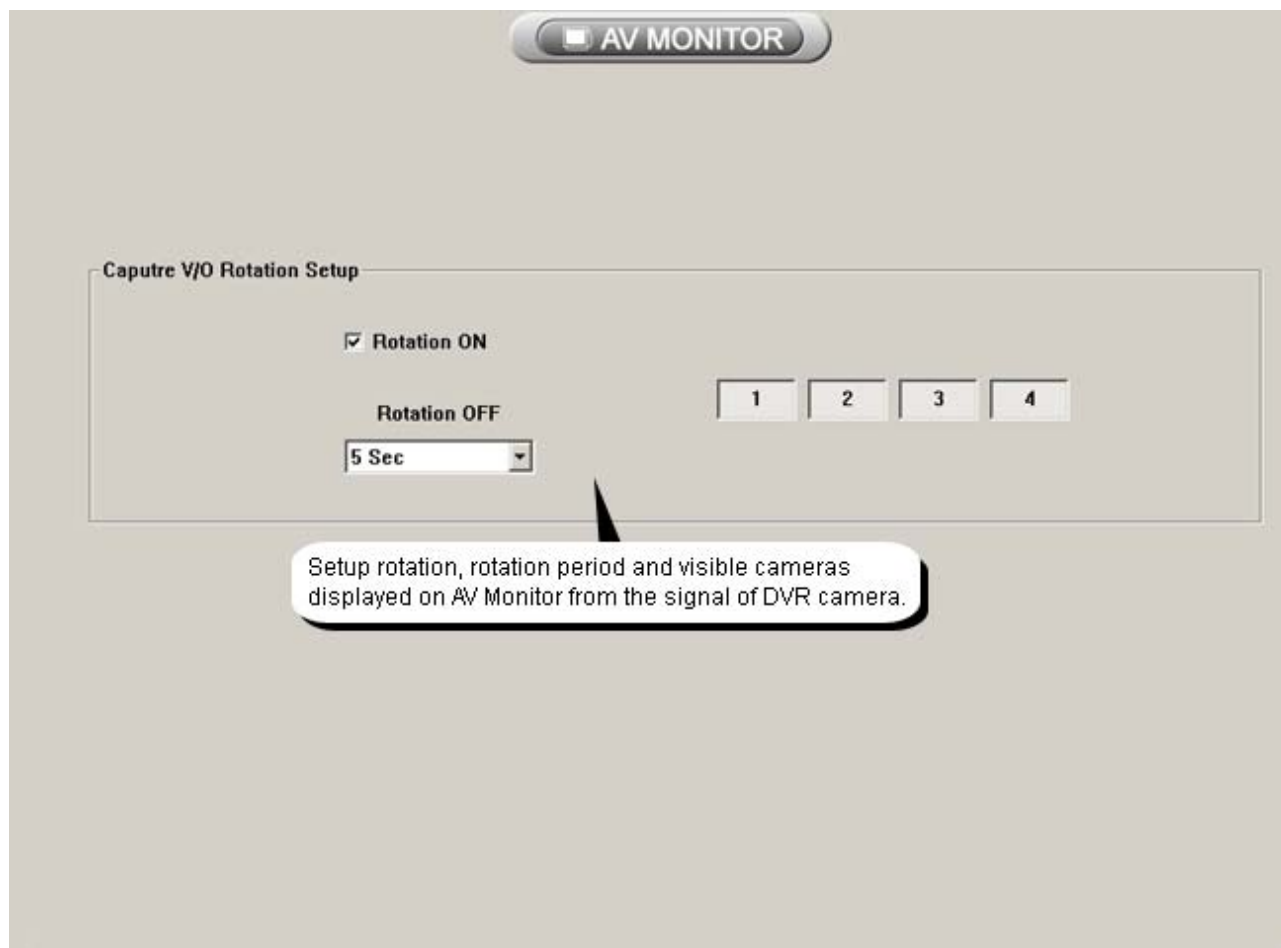

2.8 SENSOR & ALARM SETUP

Set the sensor and alarm for better monitoring. The sensor will only activate when the sensor schedule is set. The alarm will activate at sensor and motion recording mode.

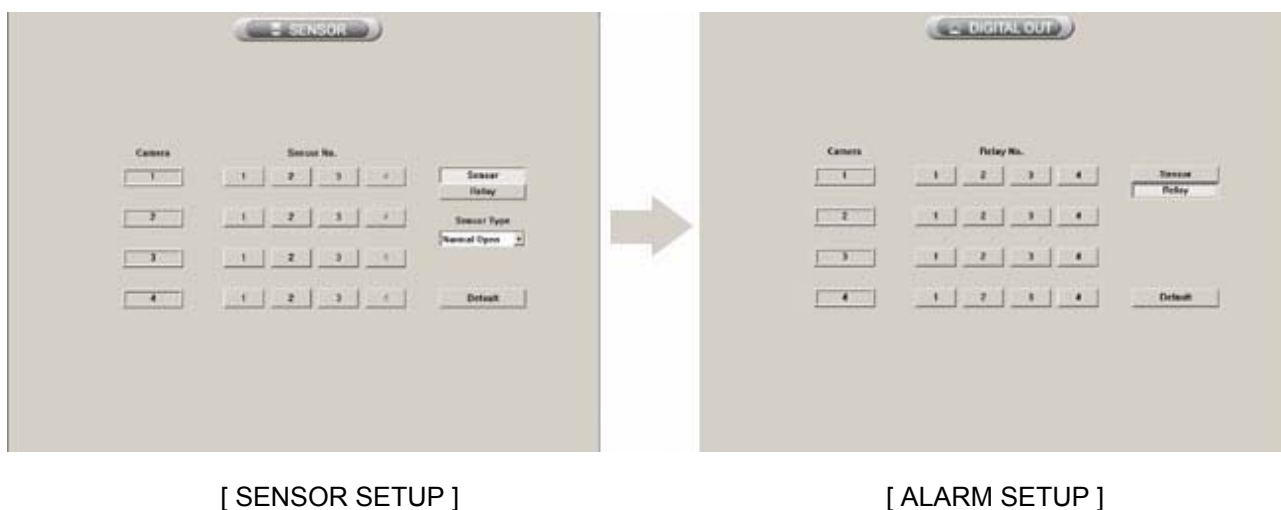

1	One sensor can link with 3 cameras.
2	One camera can link with 3 sensors maximum.
3	Sensor no.16 is used for communication. It will transmit the SAFE-DVR recording data to distant places. This sensor must be made a switch type.
4	You can select a type of sensor either 'Normal Open' or 'Normal Close'.
5	You can set 4 alarms maximum for one camera.
6	Alarm also can link with motion and sensor recording.

2.9 AUDIO SETUP

User can select cameras that will link with audio channels. To record the sound with the recording image, select the cameras and turn the Audios [On].

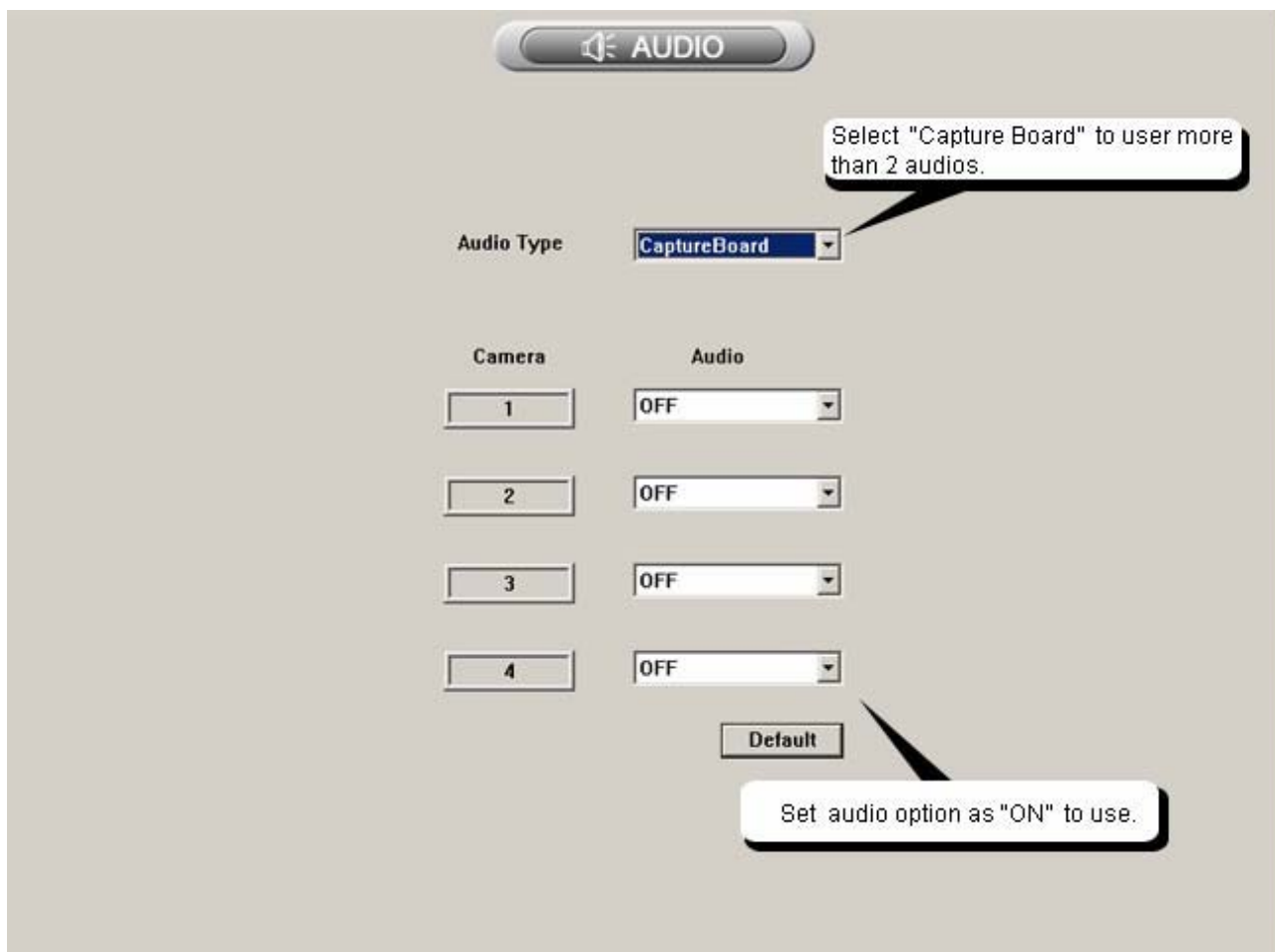
**Tip!**

You cannot use audio option on the surveillance screen unless you set at least 1 channel audio as "ON".

2.10 ACCOUNT SETUP

Admin user can add/modify/delete an ID and give it an authority for SAFE-DVR functions. Previously made IDs are on the left list and add/modify/delete for an ID is made on the right menu.

Only Admin user can do the account setup.

ACCOUNT

Show created users and their authorities.

ID	Authority
admin	Setup, Search, Backup, DVR Power
guest	Communication, RemoteSearch
1	Communication, Remote Setup, Duplex Au...
2	Communication, Remote Setup, Duplex Au...
3	Communication, Remote Setup, Duplex Au...
4	Communication, Remote Setup, Duplex Au...
5	Communication, Remote Setup, Duplex Au...

Administrator can add/modify/delete users on the add/modify/delete mode.

Add Modify Delete

Add

ID

Password

OK

Enter password again to confirm.

Authority

Setup Search

Backup DVR Power

Duplex Audio Remote Setup

RemoteSearch SAFEMODE

Communication

Enter the ID.

Add Clear

Give each user authorities of DVR access. The authorities of Safe Mode can just given to one user.

[Authority] Selected ID has an authority for a checked function.

1. Setup: An authority for setup.
2. Search: An authority for search.
3. Backup: An authority for backup.
4. SAFE-DVR Power: An authority for SAFE-DVR on/off.
5. Duplex Audio: An authority for using the duplex audio.
6. Remote Setup: An authority for the remote setup.
7. Communication: An authority for remote access to the SAFE-DVR. (Up to 5 IDs can get this authority.)

8. Safe Mode: An authority for access in Safe Mode. (Safe Mode authority is only given to one ID.)
9. Remote Search : An authority for access in M-Client
10. Setup: An authority for remote access to the camera channels unit as like as below picture.

ACCOUNT

ID	Authority
admin	Setup, Search, Backup, DVR Power
guest	Communication, RemoteSearch
1	Communication, Remote Setup, Duplex Au...
2	Communication, Remote Setup, Duplex Au...
3	Communication, Remote Setup, Duplex Au...
4	Communication, Remote Setup, Duplex Au...
5	Communication, Remote Setup, Duplex Au...

Modify

ID

Password

OK

Stream Channel Setup

1

2

3

4

Caution] Checked channels won't be displayed through client programs.

Tip! If you delete the communication users(1,2,3,4,5), you cannot create them again because user ID must be at least 3 characters.

2.11 NETWORK SETUP

User can set the functions regarding the remote access in the network setup.

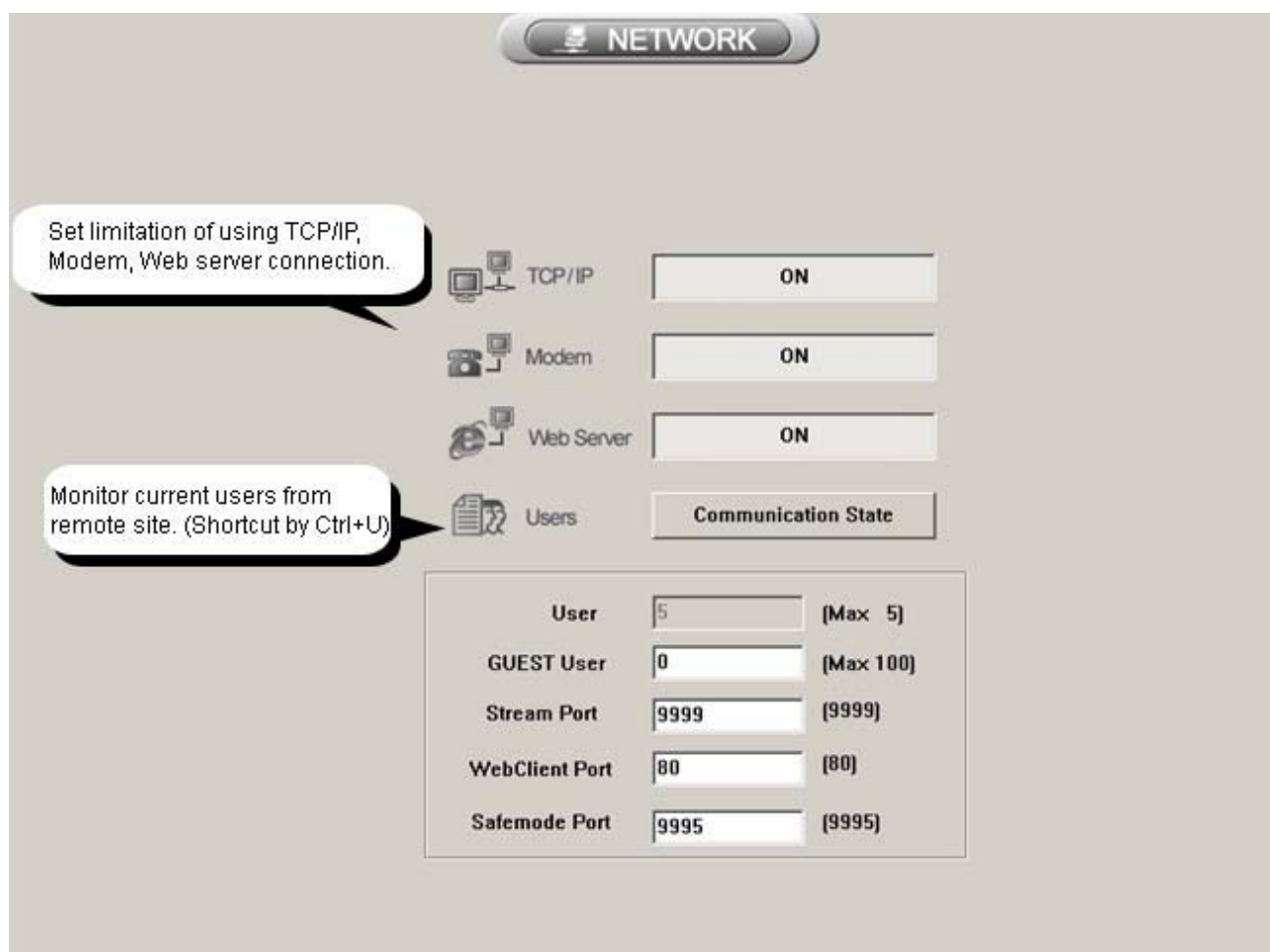

TCP/IP Permits the access through Internet to a SAFE-DVR.

Modem Permit the access through a modem.

Web Server Permit the image transmission using an web browser.

Users User can see connected user IDs, IP and functions in use. User also can disconnect them with [disconnect] button. User can see the connected user status by clicking 'Ctrl + U' in the main screen.

Guest User Set limitation of Guest Users up to 100.

Stream Port Defaulted port: 9999

WebClient Port Defaulted port: 9995

Safemode Port Defaulted port : 80

Tip! 1. User can appoint the maximum number of guest users. Guest user has no authority for search and setup, and up to 100 guest users can connect to a SAFE-DVR simultaneously. There is not such a big difference between 'User' and 'Guest user', but Guest user helps your DVR system operates better by reducing memory spending.

2. User have to change TCP/IP filtering after changing Stream Port, WebClient Port and Safemode Port. Please refer to 10.1 TCP/IP filtering

3. If you changed Stream port you have to change the HTML file in the SAFE1000N and SAFE1800 folder(C:\WSAFE1800\html\Windex.html). Please refer to the below picture.

```
<OBJECT id=Client1 classid=CLSID:938994FD-52F2-465A-B297-E808E08C32EC
width=640 height=480
codebase="WClient.CAB#version=1,0,0,13">
<PARAM NAME="OCXID" VALUE="OCX01">
<PARAM NAME="IP" VALUE="127.0.0.1">
<PARAM NAME="USER" VALUE="guest">
<PARAM NAME="PASSWORD" VALUE="guest">
<PARAM NAME="CameraID" VALUE="0">
<PARAM NAME="Mode" VALUE="4A">
<PARAM NAME="UseDirectX" VALUE="0">
<PARAM NAME="UseThread" VALUE="0">
<PARAM NAME="PORT" VALUE="NUMBER OF STREAM PORT">
</OBJECT>
```

as like as "9990"

2.12 DIET MODE SETUP

User can minimize the monitoring screen using the diet mode function.

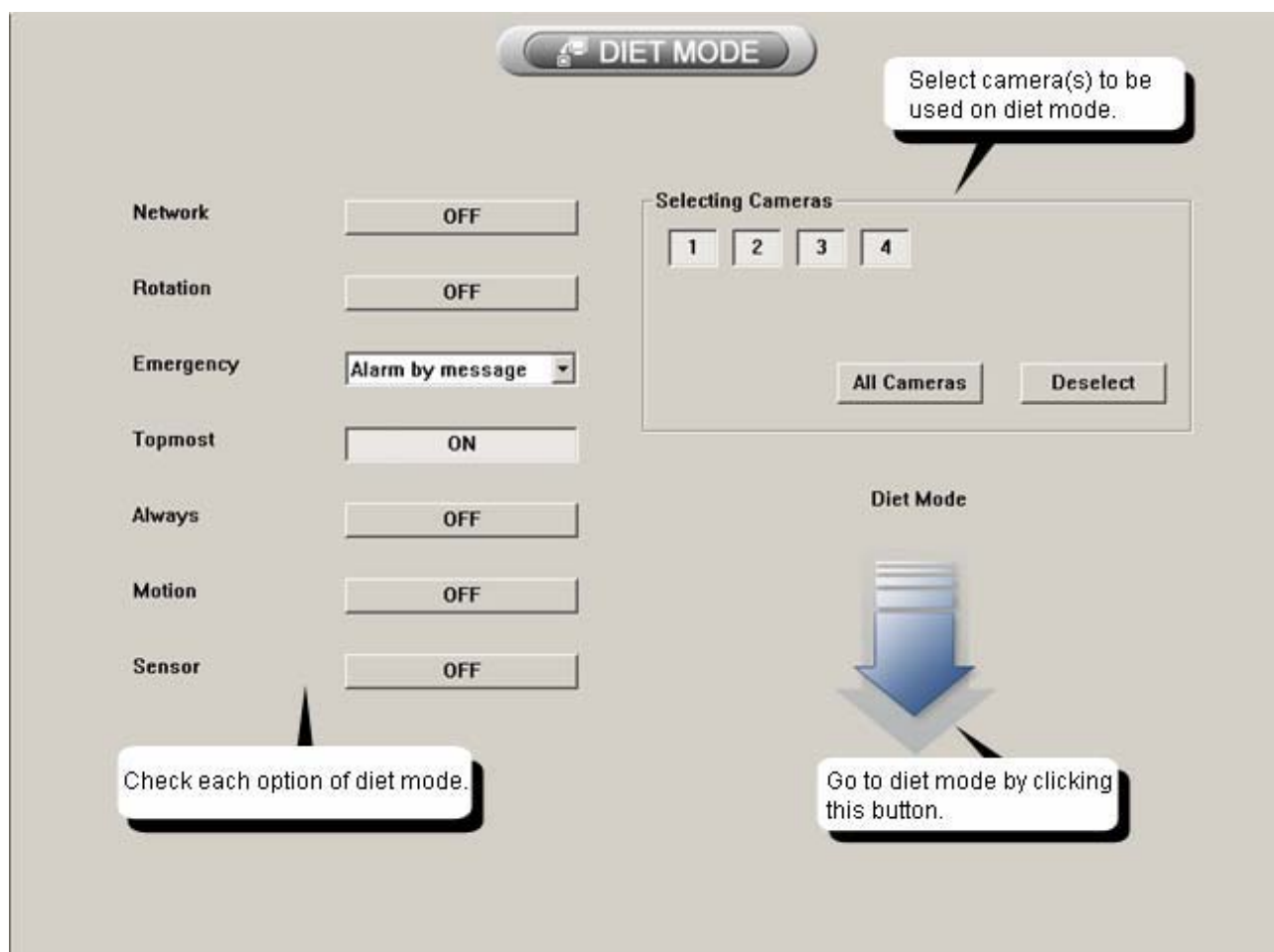

Remote Service	Turns on access to SAFE-DVR with TCP/IP, Modem.
Rotation	Turns on rotation on diet mode.
Emergency	Set emergency situation on diet mode. Return to main page: Goes back to main page for emergency. Message popup: Pops up a note for emergency.

* No use: Do not use this mode.

Always on top Always puts the monitoring screen on top.

Always recording Always record images.

Motion recording Use motion recording on Diet mode.

Sensor recording Use sensor recording on Diet mode.

Right click on the Diet mode screen to see the menu.

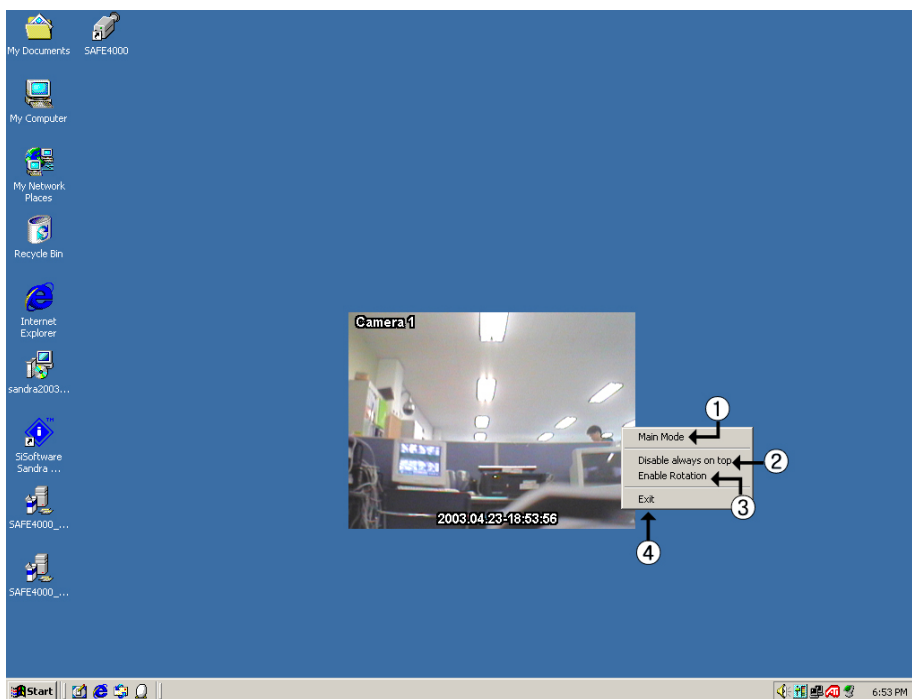

[DIET MODE]

1	Main page	Return to the SAFE-DVR monitoring screen.
2	On top	ON: Always puts the monitoring screen on top. OFF: Turns off this mode.
3	Rotation	ON: Turns on rotation on diet mode. OFF: Turns off rotation on diet mode.
4	Exit	Exit the Diet mode and turn off the SAFE-DVR system.

2.13 ETC SETUP

Set various functions on this menu.

The screenshot shows the 'ETC' setup menu with the following options and callouts:

- Use of Ctrl+Alt+Del key:** Points to the 'Ctrl + Alt + Del' option, which is currently set to 'OFF'.
- Set shell option of Windows:** Points to the 'Shell Option' dropdown menu, currently set to 'MPEG'.
- Rotation time of screen in surveillance mode:** Points to the 'Rotation Time[Sec]' dropdown menu, currently set to '5'.
- Option of rebooting or shutdown after ending DVR program:** Points to the 'Power-Off Option' dropdown menu, currently set to 'Exit to Windows'.
- Emergency Data Transfe:** Points to the 'Emergency Data Transfe' option, which is currently set to 'ON'.
- Matrix Mode:** Points to the 'Matrix Mode' dropdown menu, currently set to 'ALL OFF'.
- Event log deletion cycle:** Points to the 'Event log deletion cycle' dropdown menu, currently set to 'OFF'.
- Watchdog:** Points to the 'Watchdog' option, which is currently set to 'ON'. A callout explains: "Watchdog is rebooting operation when the system faces unstable problems."
- CD-RW Program:** Points to the 'CD-RW Program' option, which is currently set to 'Find'. A callout explains: "Select CD-RW program for backup."
- Periodically delete event log to save disk space:** Points to the 'Event log deletion cycle' dropdown menu.
- Set location of each screen as user pleases just by dragging:** Points to the 'Caption' label above the drive selection area.

The drive selection area at the bottom shows:

- Available Drive:** [C:] 03173MB / 04996MB
- Recording Drive:** [D:] 06589MB / 71343MB
- Navigation buttons: >> and <<
- Labels: Available / Total

A callout for the drive selection area states: "Set drives for recording. 'Recording Drive' is now available for recording."

Power-Off Option

There are 3 types of power options.

Exit to window: Exit to window when the SAFE-DVR program is over.

SAFE-DVR system restart: Restart the SAFE-DVR system when the SAFE-DVR program is over.

SAFE-DVR power off: Power off the SAFE-DVR system when the SAFE-DVR program is over.

Emergency Data Transfer

If you installed a sensor board, you can use this function.

If you didn't install a sensor board, this function will transmit the DVR recording data to distant places.

Codec

SM4 for SAFE4400

MPEG4 for SAFE2000, SAFE2200, SAFE4000, SAFE4000(T), SAFE4200, SAFE4200(T), SAFE4400

Low speed line

For 56K modem you can choose high A/B/C compression of camera set-up as below picture.

The screenshot shows a configuration window titled 'CAMERA'. It contains a table with columns for Camera, Recording, Screen Visible, Camera Name, PTZ Protocol, Compression, Resolution, and Video Type. The 'Compression' dropdown for Camera 2 is open, showing options: HighA, HighB, and HighC.

Camera	Recording	Screen Visible	Camera Name	PTZ Protocol	Compression	Resolution	Video Type
1	ON	Visible	Camera 1	ORX1000	Medium	320 * 240	NTSC
2	ON	Visible	Camera 2	ORX1000	HighA HighB HighC	320 * 240	
3	ON	Visible	Camera 3	ORX1000	Medium	320 * 240	Default
4	ON	Visible	Camera 4	ORX1000	Medium	320 * 240	Protocol

Caption

User can choose caption of screen like as time, camera name and recording type.

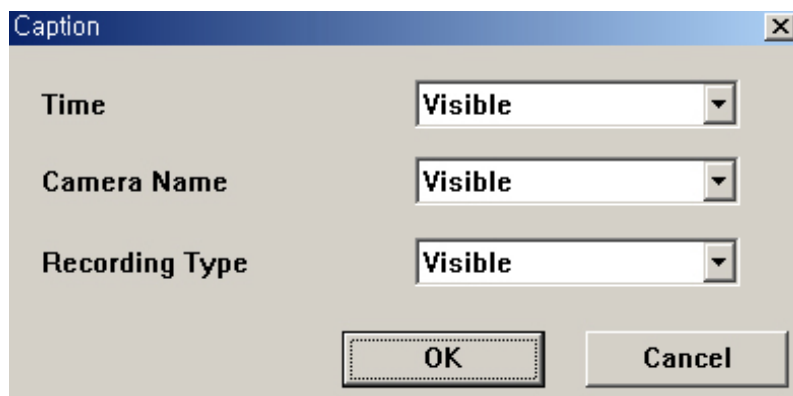

User can select a CD-Writer program as below.

1	Press 'Search' at [CD-RW Select].
2	<p>A window will pop up after pressing the [Search] button. You can press [Search] on this window to find the program file you want.</p> 
3	When the search is over, press [OK] to end the setting.
4	Go to the Monitoring screen and press the [Backup] button. Start backup after selecting CD-RW as a backup device.

2.14 SOFT KEYBOARD

The Soft Keyboard is a function that can be used when there is no keyboard connected.

User can use this by clicking the Soft Keyboard button. Move and click the mouse on the Soft Keyboard

to use.



2.15 CONFIRM & CANCEL

	Confirm	Save all settings and exits the program
	Cancel	Cancel all settings and exits the program

3.1 INTRODUCTION TO SURVEILLANCE

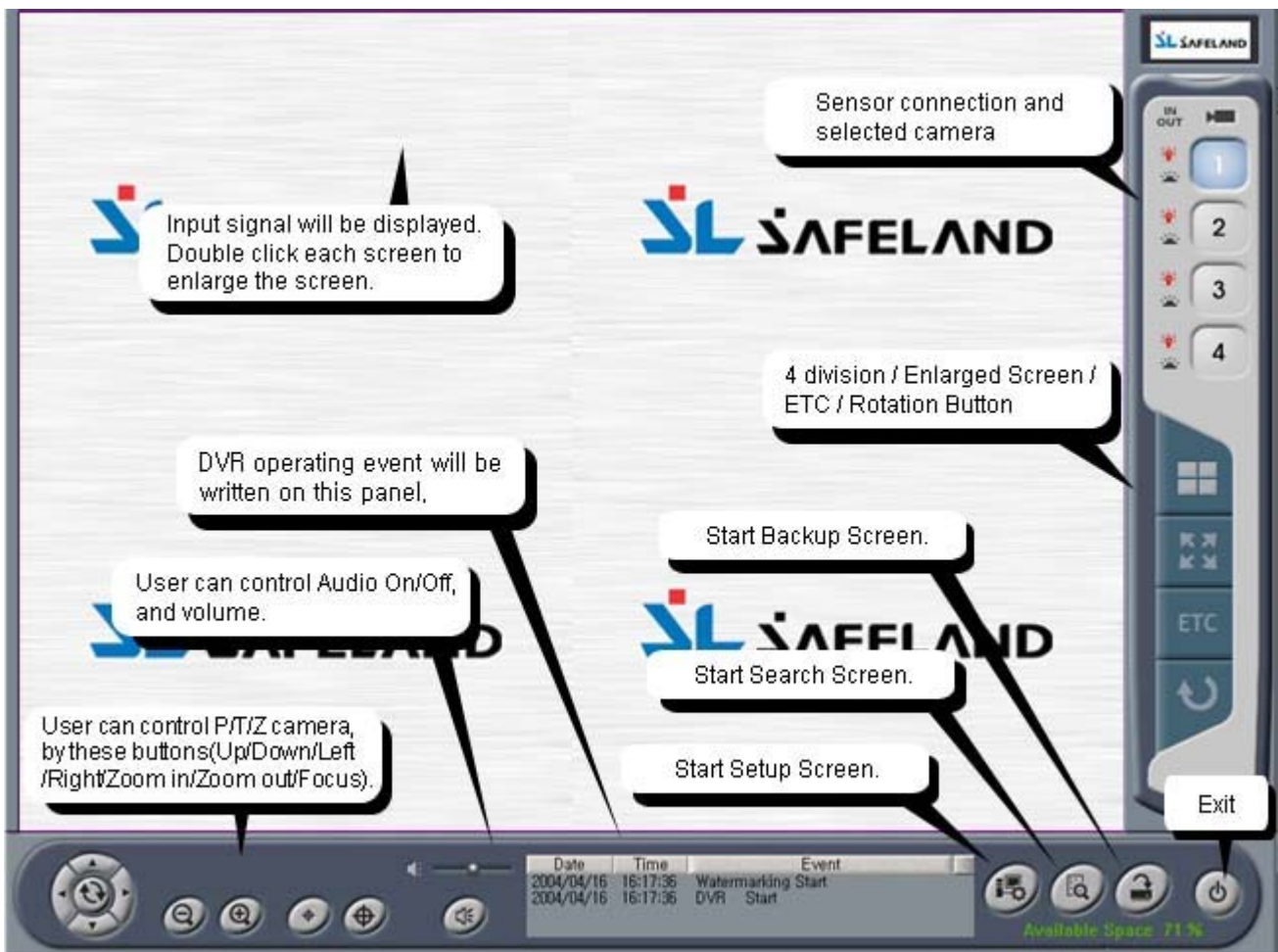

Tip! When using SAFE-DVRX-1000, user can use Light On/Off function in the [ETC] button. In case of using this function, you can control the light connected with SAFE-DVRX-1000.

Please set audio option on the setup mode to use audio in surveillance screen.

Right click on sound button will show the sound selection option as below.



3.2 RECORDING STATUS



1	Camera Name
2	Recording Status

[Display Recording Status]

Audio Use	A		
No Recording	No signature	Continuous Recording	C
Motion Recording	M	Sensor Recording	S

3.3 SAFE-DVR INFORMATION WINDOW

You can see the version and kind of the SAFE-DVR you have, by pressing [Ctrl + V].

You can see the version and the build date of the SAFE-DVR.

It is useful when you ask for After Service.

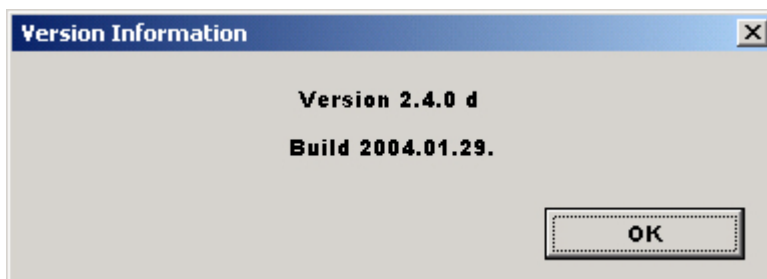

3.4 EVENT & LOG HISTORY WINDOW

Every important operation will be written in the log file. This information will not be removed before reinstalling DVR program. It can be very useful information because it will be a clue when some accidents happen. Please confirm it by pushing [Ctrl+E] on your keyboard.

Event Viewer

2005-02-18 LOG1 LOG2 Return Close

User	Event	Date	Time	Remarks
	DVR Start	2005/02/18	10:23:45	2.8.5 2005.02.16
admin	Watermarki...	2005/02/18	10:23:45	
	DVR End	2005/02/18	10:24:01	
	Explorer	2005/02/18	10:24:23	
	ToolBox Start	2005/02/18	10:24:50	
	Multimedia ...	2005/02/18	10:24:57	
	ShortCut St...	2005/02/18	10:25:05	
	Shortcut	2005/02/18	10:25:21	mspaint.exe
	Shortcut	2005/02/18	10:26:54	mspaint.exe
	Shortcut	2005/02/18	10:28:06	mspaint.exe
	DVR Start	2005/02/18	10:29:36	2.8.5 2005.02.16
admin	Watermarki...	2005/02/18	10:29:36	
	Setup - In	2005/02/18	10:29:43	
admin	Setup - Out	2005/02/18	10:29:51	
admin	Setup info	2005/02/18	10:29:51	Setup info
	Shell Setup...	2005/02/18	10:29:51	
admin	DVR End	2005/02/18	10:29:56	
admin	DVR Start	2005/02/18	10:31:55	2.8.5 2005.02.16
	Watermarki...	2005/02/18	10:31:55	
	Setup - In	2005/02/18	10:32:06	
	No Signal	2005/02/18	10:32:45	Cam[4]
admin	Setup - Out	2005/02/18	10:36:50	
admin	Setup info	2005/02/18	10:36:50	Setup info
admin	Setup - In	2005/02/18	10:37:01	
admin	Setup - Out	2005/02/18	10:37:11	
admin	Setup info	2005/02/18	10:37:11	Setup info
admin	Setup - In	2005/02/18	10:37:21	
admin	Setup - Out	2005/02/18	10:39:30	

In the LOG2 you can find setup information like as camera, frame, schedule, motion, audio, network, authority and ETC.

Event Viewer

2005-02-18 LOG1 LOG2 Return Close

Camera	Frame	Schedule	Motion	Audio	Network	Auth	Etc
		1	2	3	4		
NTSC/PAL		NTSC	NTSC	NTSC	NTSC	NTSC	NTSC
Record		ON	ON	ON	ON	ON	ON
PTZ		ORX1000	ORX1000	ORX1000	ORX1000	ORX1000	ORX1000
Compress		Medium	Medium	Medium	Medium	Medium	Medium
Resolution		320X240	320X240	320X240	320X240	320X240	320X240

3.5 CONNECTED USER STATUS

You can check the connected user state from remote sites by pressing [Ctrl+U].

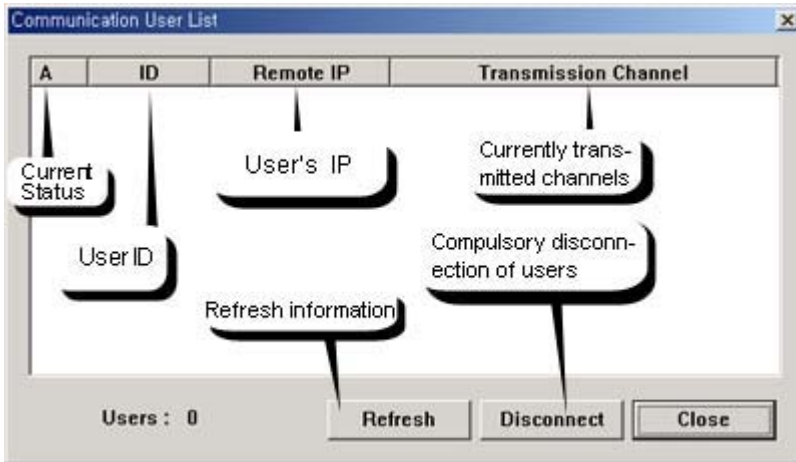

4.1 SEARCH SCREEN FORMATION

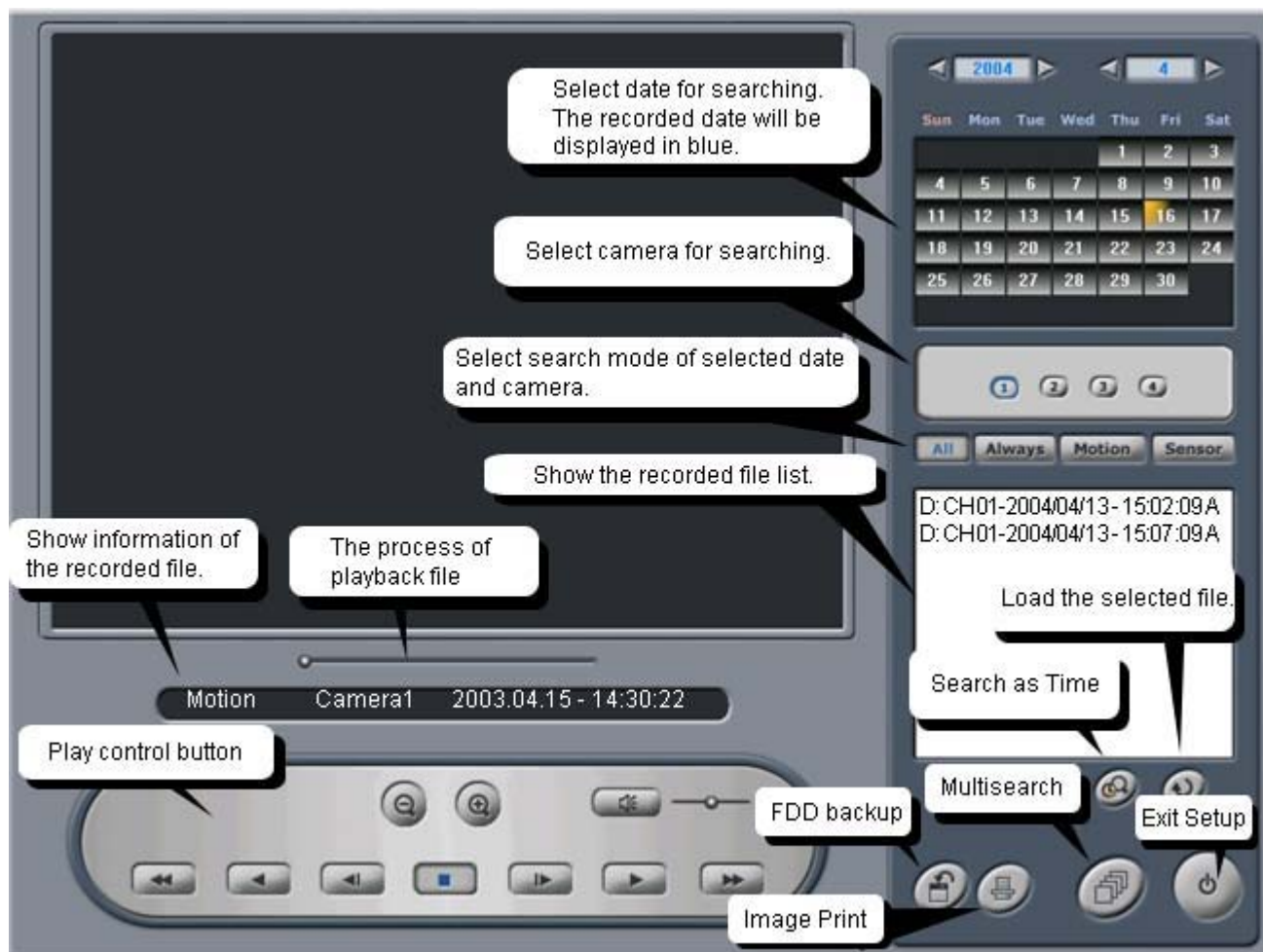

4.2 PLAY CONTROLS

You can control playing by using Play Control buttons.

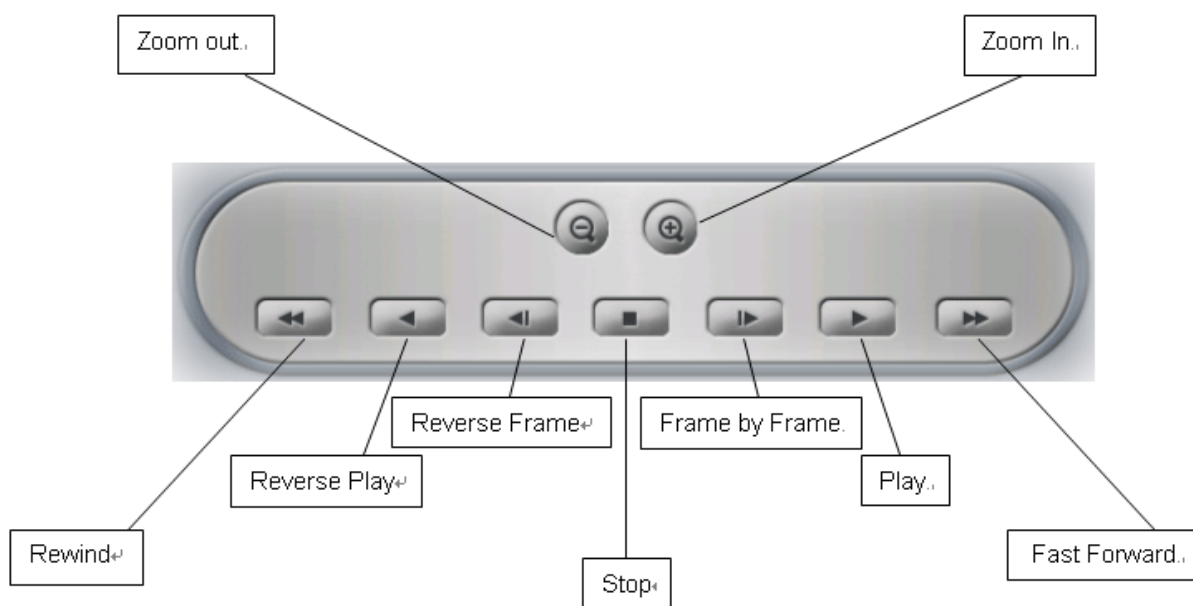

4.3 VIDEO SEARCH

Follow these steps to search and find video files.

- (1) Select a date to search using calendar.(The color of the date with recorded images are in blue)
- (2) Select a camera to search
- (3) Select a recording mode for filtering. (All, Always, Motion, Sensor)
- (4) Select a file on the list and press [Load] button. The meaning of list is as below.

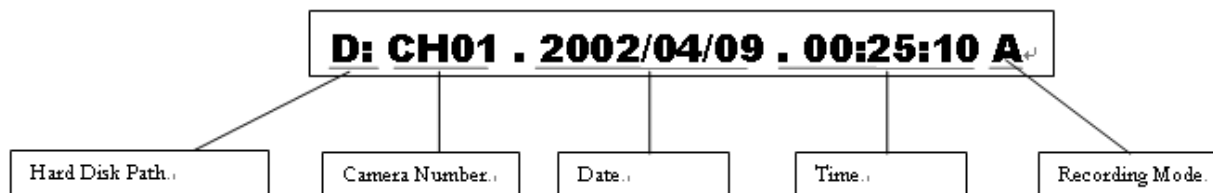

- (5) The selected file will be displayed on the screen.

4.4 AUDIO PLAY

The followings are how to play a recorded file with audio.

- (1) Select video file recorded with audio.
- (2) Load selected data.
- (3) Turn on or turn off the audio by press "audio button"
- (4) Adjust audio volume with slide bar.

4.5 IMAGE Backup(FDD Backup)

Follow these steps to save a specific image of the loaded video into a floppy diskette.

- (1) Press the [Stop] button at the desired frame during play.
- (2) Insert floppy disk into the FDD.
- (3) Press [Save] button.
- (4) Select a graphic format.
- (5) Pressing [OK] button will save the selected image into the floppy disk.

4.6 IMAGE PRINT

User can print out consecutive 8 images from the loaded video.

Follow these steps to print out images.

- (1) Press [Stop] button at the desired frame during play.
- (2) Press [Print] button.
- (3) Adjust the number of frames to print out.
- (4) Press [OK] button will print out the selected image(s).

Note Please confirm if default printer is connected before Image Print.

5.1 INTRODUCTION TO MULTI-SEARCH

You can search the images of not only 1 channel but for up to 4 channels simultaneously.

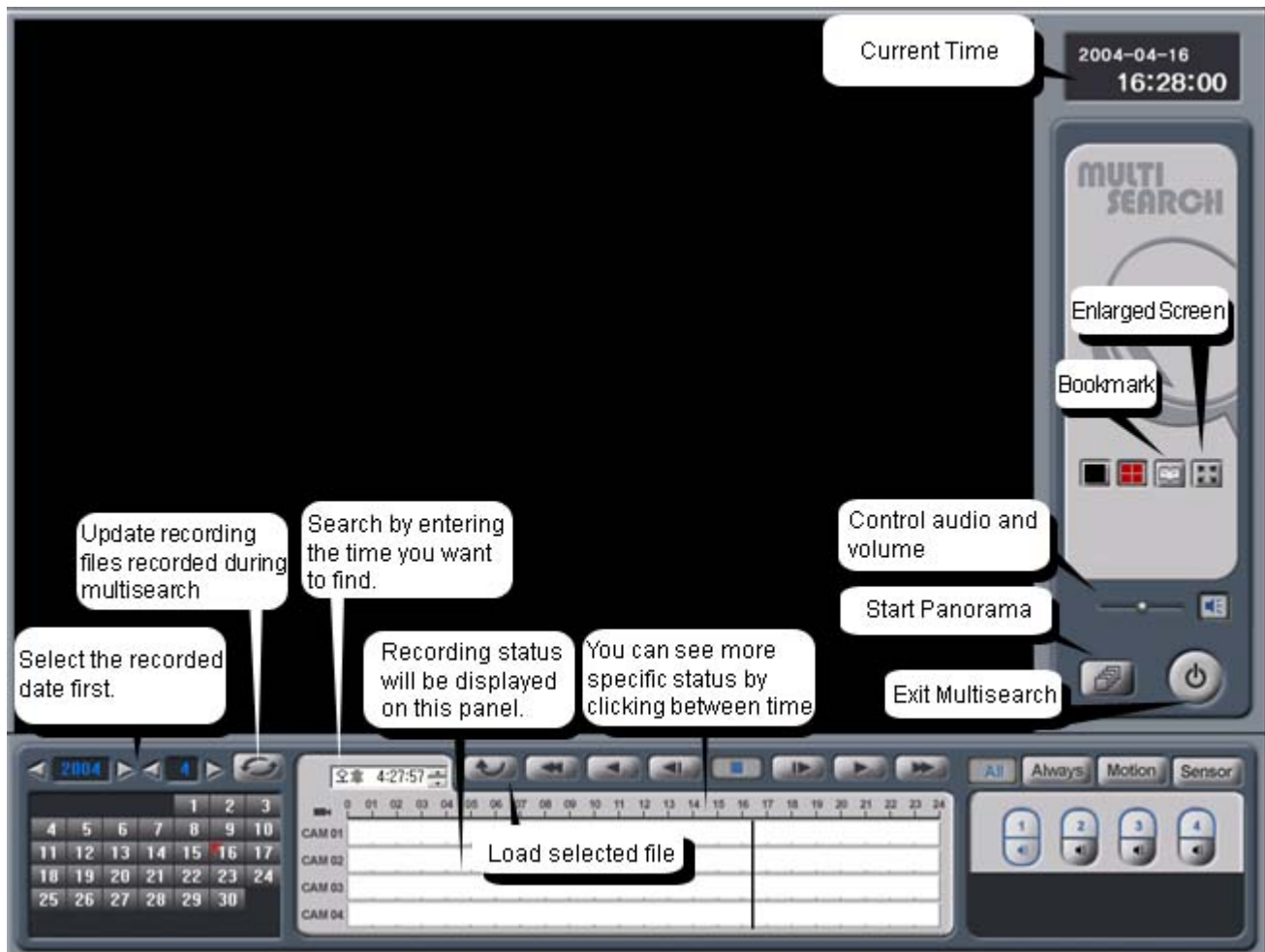

5.2 MULTI - SEARCH

Follow these steps to use the multi search function.

- (1) Select a date to search using calendar. (The date with recorded images turns to blue.)
- (2) Select a time to search using up-down buttons. Also user can select a time to search by clicking the graph. Selected time is displayed as black vertical line.

Each line means as followings.

- Selected Time** Black vertical line.
- Always** Red zone (Continuous recording mode).
- Motion** Blue zone (Motion Detection recording mode).
- Sensor** Green zone (Sensor recording mode).

- (3) Select recording mode, SAFE-DVR offers next 4 options.(All / Always / Motion / Sensor)

- (4) Now select the video channel which will be loaded. Press the video channel, and then selected buttons are activated. Press again, and then selected buttons are deactivated. And User can also select 1 audio channel to play with. User must set up same audio channel which is set in Setup screen.

(5) After selecting date, time and channel, press [Load] button.

(6) Selected video data will be appeared like next picture. How to play is same with Search screen.

5.3 ENLARGE MODE



Most of button functions are same.

5.4 BOOKMARK

This screen will be displayed when you click bookmark button in multisearch. Bookmark is useful when you want to remember a special point during multisearch process.

After clicking bookmark button, press 'Add' button and enter the information on the space. Later, just double-click will take the slider bar to the bookmarked time point.

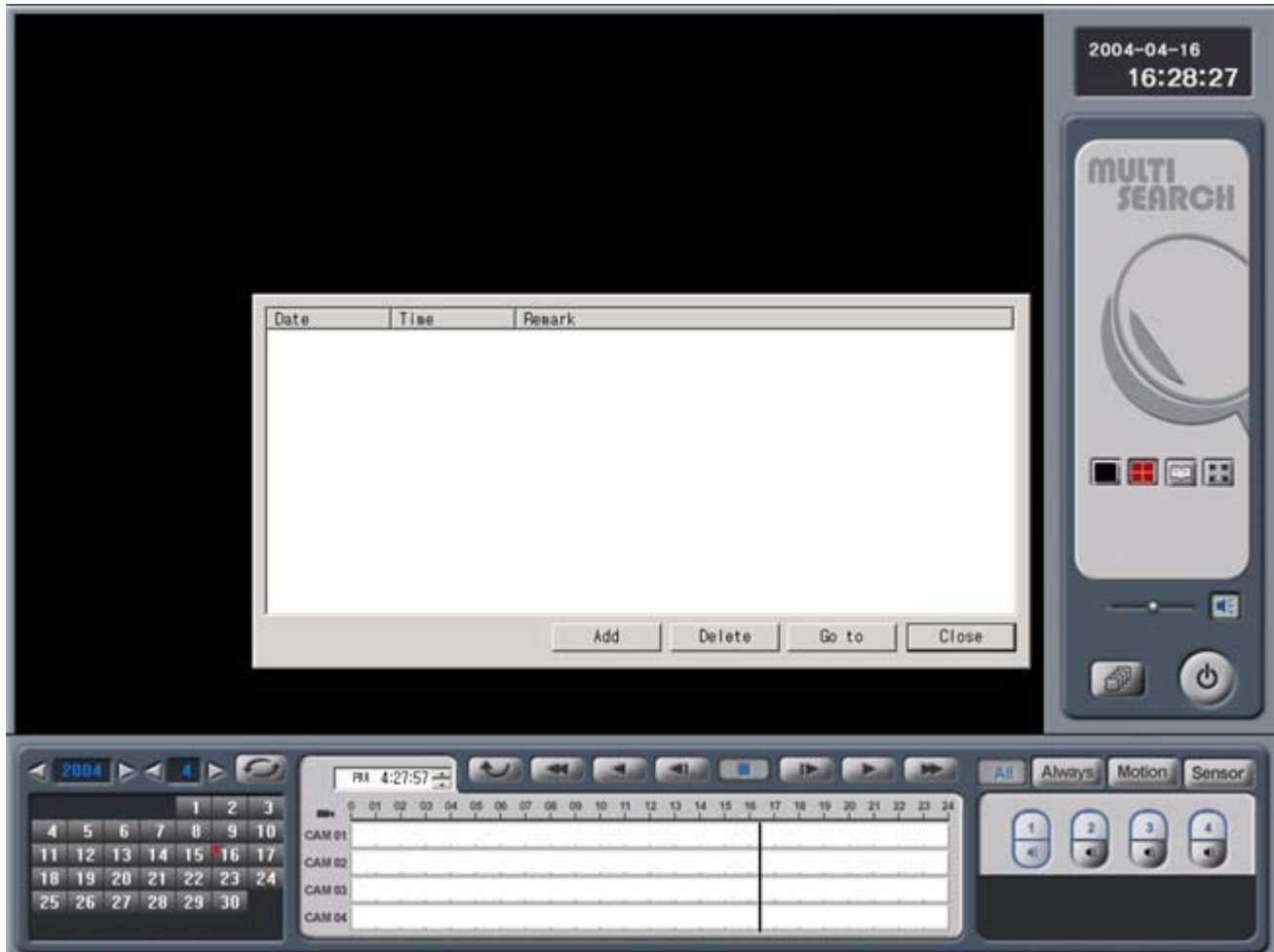

6.1 INTRODUCTION TO PANORAMA SEARCH

Panorama is 1 channel - search for more specific playback. It is convenient to use panorama search for specific playback because it shows total 18 successive images in a screen and offers many functions, such as image adjustment, image print, FDD backup, smart search.



6.2 IMAGE PRINT

In the panorama mode, user can print desired frames by his/her preference in various mode – 1X2, 2X4, 3X6. First, click frames user want to print out in the panorama search screen. Then the selected frames are outlined with blue. After that, press [Print] button to open the print window. And then, select the desired print mode and print the frames.

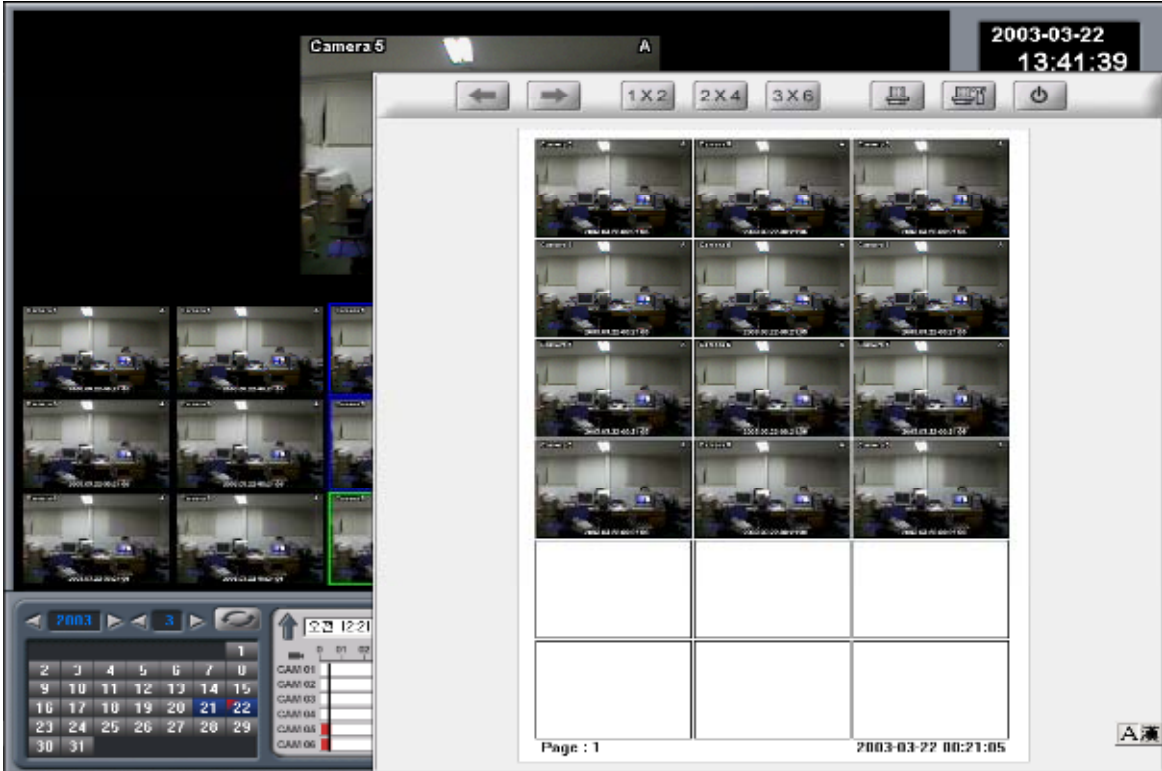

You can also print in various modes.



6.3 PANORAMA ENLARGED-SCREEN







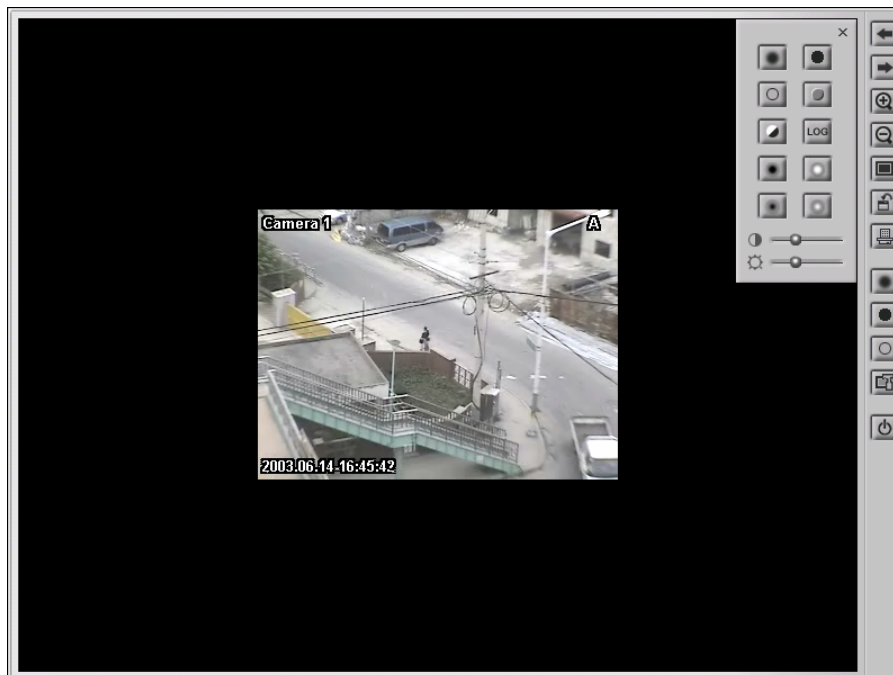

You can also use the zoom in function in the panorama screen. You can see the panorama search screen in full screen mode and go back to original screen.



6.4 IMAGE ADJUSTMENT



<IMAGE ADJUSTMENT>

1		Blur	Soften the selected image.
2		Sharpen	Focus blurry images by increasing the contrast of adjacent pixels.
3		Edge Detect	Focus the color boundary line.
4		Embossing	Make the image appear raised or stamped by converting its fill color to gray and tracing the edges with the original fill color.
5		Gray	Turn the image to gray-color.
6		Log	Detect the boundary line.
7		Erosion	Enlarge the background and reduce the object
8		Dilation	Enlarge the object and reduce the background
9		Opening	Remove the noise and keep the previous size.

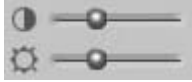
10		Closing	Soften the boundary line and remove the little holes.
11		Brightness / Contrast	Control the brightness and contrast of images.

6.5 SMART SEARCH

Smart search can detect movements in consecutive frames. This function is useful for lots of recorded frames of zones with little movements

- (1) In the panorama search screen, press 'smart search' button.
- (2) Set the zones (up to 5 zones) for motion detecting as motion detecting recording. While playing the images, the SAFE-DVR stop playing when it detects movements
- (3) Right click the smart search button to set the sensitivity. And with [Default zone] button, user can cancel the appointed zones.

7.1 INTRODUCTION TO BACKUP

User can back up recorded video to a CD-RW, an External HDD, and a DVD.



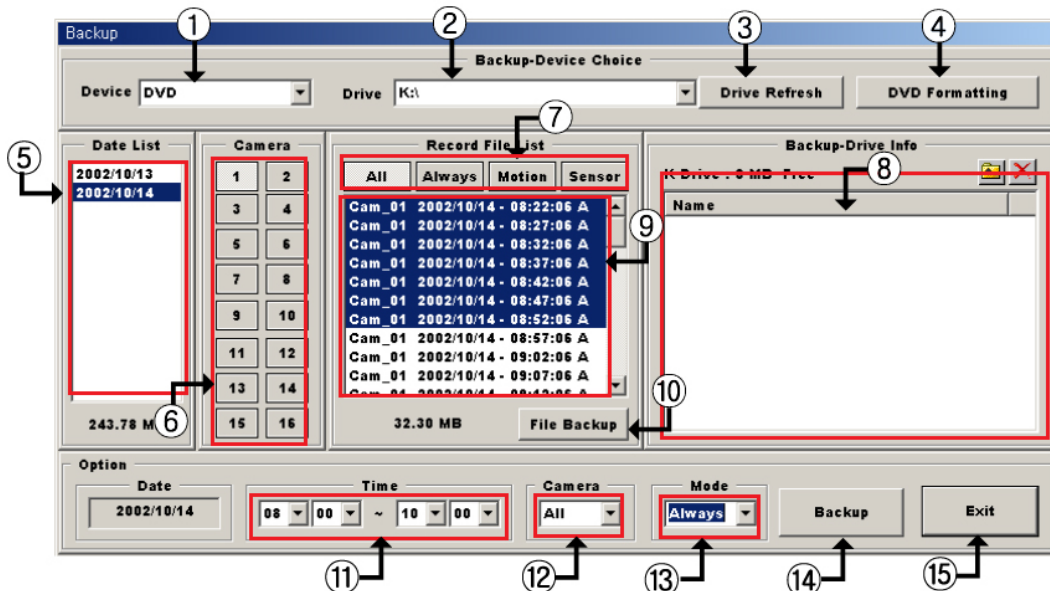

Note To back up recorded video to CD-RW, any kind of CD Writing program will be needed – Ahead Nero, CD creator or etc. please refer to its manual for further information.



1	Backup Device	Allow user to select a backup media to use among DVD / CD-RW / External HDD.
2	Path	Allow user to select a path to which back up the recorded file.
3	Refresh Button	Refresh a file list of the selected backup media.
4	DVD Format Button	Format a DVD-ROM.
5	Date List	Show user the dates which have recorded video. Select one from the list and all files of camera 1 in the selected date will be shown by default. Note that user cannot back up video of current date.
6	Camera Button	Allow user to select a camera to back up.
7	Recording Mode Button	Allow user to select a recording mode to filtered list of video.

8	Backup Media Status	Show user the list of video that the selected backup media currently has.
9	File List	Show user the list of video fit to option 5,6,7. User can select video to back up from this list.
10	File Backup	Allow user to back up selected video to the associated backup media.
11	Time Select	This option allows user to back up video using time range.
12	Camera Select	Allow user to select a camera to back up. (This option is associated with [Time Select] option.)
13	Recording Mode Select	Allow user to select a recording mode of video to back up. (This option is associated with [Time Select] option.)
14	Backup Button	Back up video fit to option 11,12,13. .
15	Exit Button	Exit to Monitoring Screen.

7.2 BACKUP SELECTED FILE







1	Select a backup media to use.	
2	Select a path for backup.	
3	Select a desired date to back up from [Date List].	
4	Select a camera to back up.	
5	Select a recording mode and select video to back up from [Record File List]	

6	Press [File Backup]. In a while, backup process will be completed. To exit to Monitoring Screen, press [Exit] button after backup.	
---	--	---

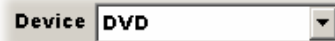
To use HDD or DVD for backup, user must specify the [Drive]. If the media is not formatted please format that using [HDD FORMAT] or [DVD FORMAT] button prior to backup process.

7.3 BACKUP BY TIME

Follow these steps to back up video using time range.

1	Select a backup media to use.	
2	Select a drive letter of the backup media.	
3	Select a desired date. Using Time Option, select time range.	
4	Select a camera to back up. (Selecting [ALL] allows user to back up all cameras.)	
5	Select a recording mode.	
6	Pressing [Backup] button will start backup process.	

7.4 FILE SAVING STRUCTURE OF SAFE-DVR FOR BACKUP

User is able to get the system to back-up as DVD or CD-RW type. In this case, hardware for the recording time should be setup and installed by software.(for example, user need to setup CD-RW hardware and install the software, 'Easy CD Creator' to back-up as CD-RW.) The tree-structure of recorded image will be helpful for users to back-up recorded image files as DVD or CD-RW type. The structure made on D or E driver is as follows;

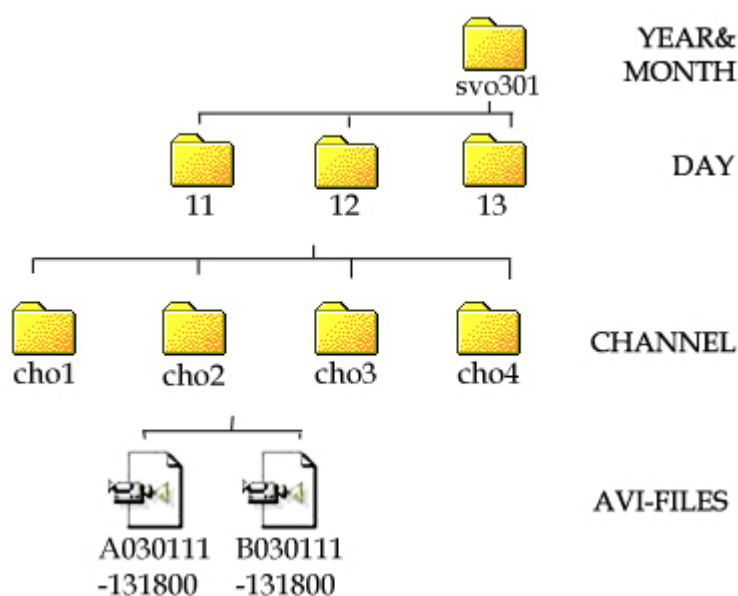

To back-up the recorded images from your HDD to other types of media, DVD or CD-RW, please turn off the SAFE-DVR program to avoid any troubles. (Recorded images are in D or E drive.)

8.1 OPEN PROTOCOL

Open Protocol (user setup) is a function which enables user to customize and edit P/T/Z cameras' protocols. It will make the user feel safe when he/she gets new P/T/Z cameras which is not embedded in SAFE-DVR.

8.2 STARTING OPEN PROTOCOL

User can start the open protocol from the Setup Screen. Follow these steps to edit P/T/Z cameras' protocols

1	Enter the Setup Screen by pressing [Setup] button on the Monitoring Screen.	
2	Press the [Protocol] button on the Setup Screen to bring up the Open Protocol Window.	

8.3 OPEN PROTOCOL SETUP

Open Protocol Window is as below.

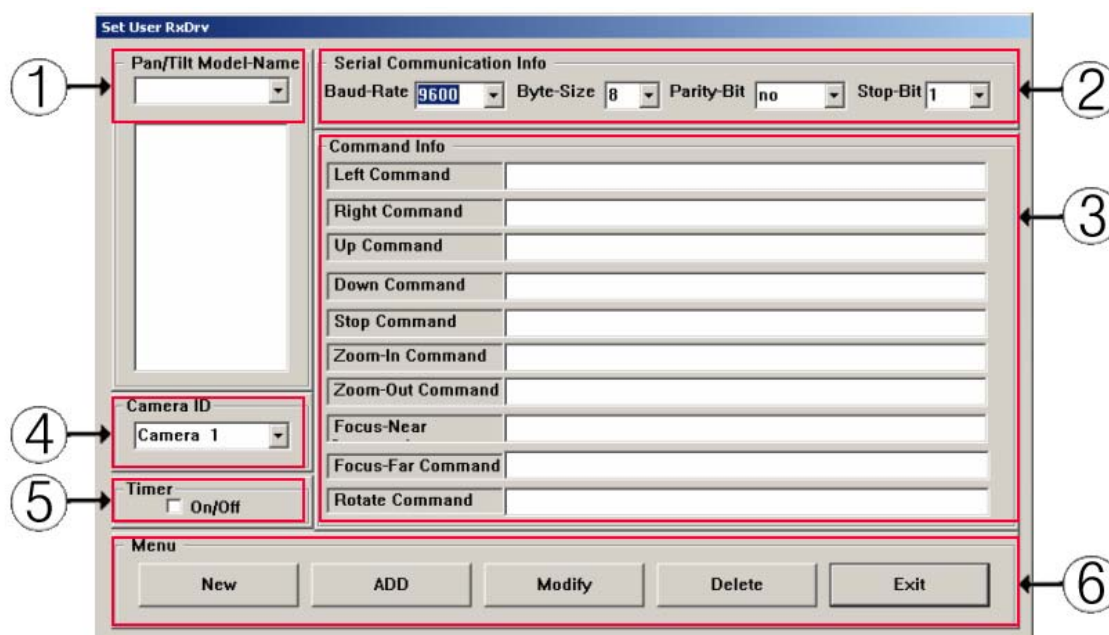

1	Pan/Tilt Model-Name	Enter the product name of the P/T/Z camera to add. Once added, it will be stored and shown in the list box.
2	Serial Communication Info	User must adjust Baud Rate / Byte Size / Parity Bit / Stop Bit for proper communication between SAFE-DVR and P/T/Z camera. Refer to P/T/Z camera manual to get exact values.

3	Command Info	User must input each command values. Please note that user should calculate each value with the P/T/Z camera manual.
4	Camera ID	Select a P/T/Z camera ID to work for. To set multiple cameras up, user must input each different value for each camera ID. (Ex: When there are 5 P/T/Z camera named A, user might need to input 5 different Commands Set for each camera ID from 1 to 5.)
5	Timer	Check this option when the installed cameras use Timer. (To discern whether the camera needs this, please refer to P/T/Z camera manual or contact the manufacturer.)
6	Buttons	User can add, delete or modify the values.

8.4 OPEN PROTOCOL EXAMPLE

When there is a P/T/Z camera named A, user can set the camera up as following.

1. Request P/T/Z protocol manual to the manufacturer
2. Calculate the values for Up / Down / Left / Right commands and Zoom in /Zoom out /Focus Near/Focus Far commands with the manual.
3. Press the [New] button to create a new command set.

4. Select the values for Serial Communication. (The most common values is 9600 / 8 / No / 1.)
5. Select a camera ID. (4 channel SAFE-DVR user checks 1~4 camera IDs).
In this example, we will check camera no.1
6. Enter the calculated command.
7. Each P/T/Z camera has its own protocol commands format but most P/T/Z cameras use hex values for its commands. So user needs to calculate hex code to get right P/T/Z command values. For example, when there is a P/T/Z camera which uses 3 bytes P/T/Z commands.

ITEM 1	ITEM 2	ITEM 3
Camera ID	Command Code	Checksum*

*Checksum is a value which is used for checking if the transmitted value is proper.

Checksum value will be calculated by each unique numerical formula.

Suppose that the left move command of P/T/Z camera A is '0x81' and its ID is '0x01'.

And its checksum formula is '100 – (ITEM 1 + ITEM 2)'. Then the value for left command is as bellows.

[01 (Camera ID)]+ [81('0x' must be removed.)]+ [100 – (01 + 81) (Checksum)] =01, 81,7e

(Each value should be separated by ', '.)

Refer to [1.5 Hexadecimal Numeration System] to calculate this in easy way.

8. Repeat step 7 until all the commands needed are filled.

When finished press the [ADD] to save the values.

9. When there is another P/T/Z camera to set up, choose a different Camera ID with the P/T/Z protocol.

And repeat step 6~8.

Press the [Modify] key to apply changed values.

10. To edit, select the model and change the value and press [Modify].

To delete the information, select the model and press [Delete].

11. When finished, press the [Exit] key to close the Open Protocol Window and select the P/T/Z protocol in the Setup Screen.

8.5 HEXADEMICAL NUMERIC SYSTEM

User can calculate hexadecimal numbers using a calculator provided with window.

1. Select [Start] → [Program] → [Accessories] → [Calculator].

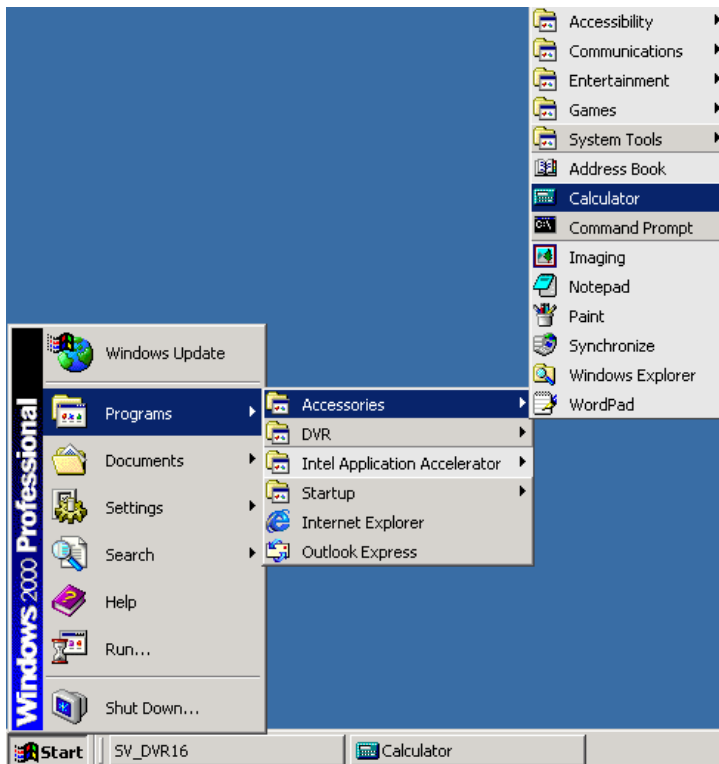

2. Select [View] -> [Scientific] to expand the default calculator.

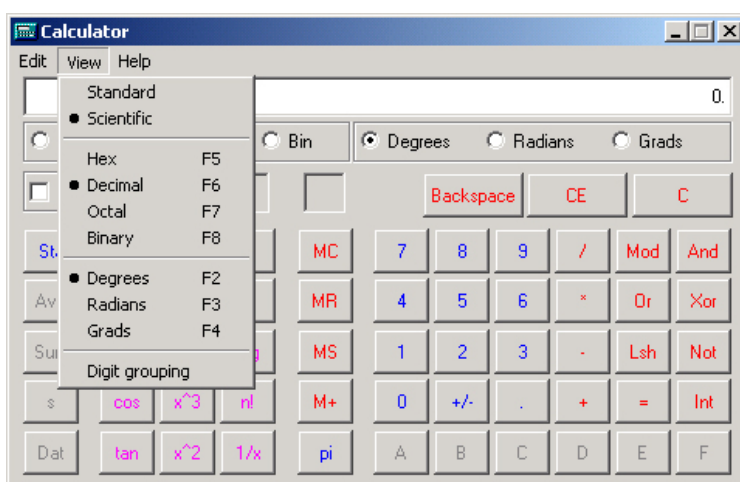

3. Check [Hex] and [Byte] to calculate hexadecimal byte numbers.

9.1 SAFE-DVR WEB WERVICE

Web service of SAFE-DVR is for remote monitoring without program in user's PC.

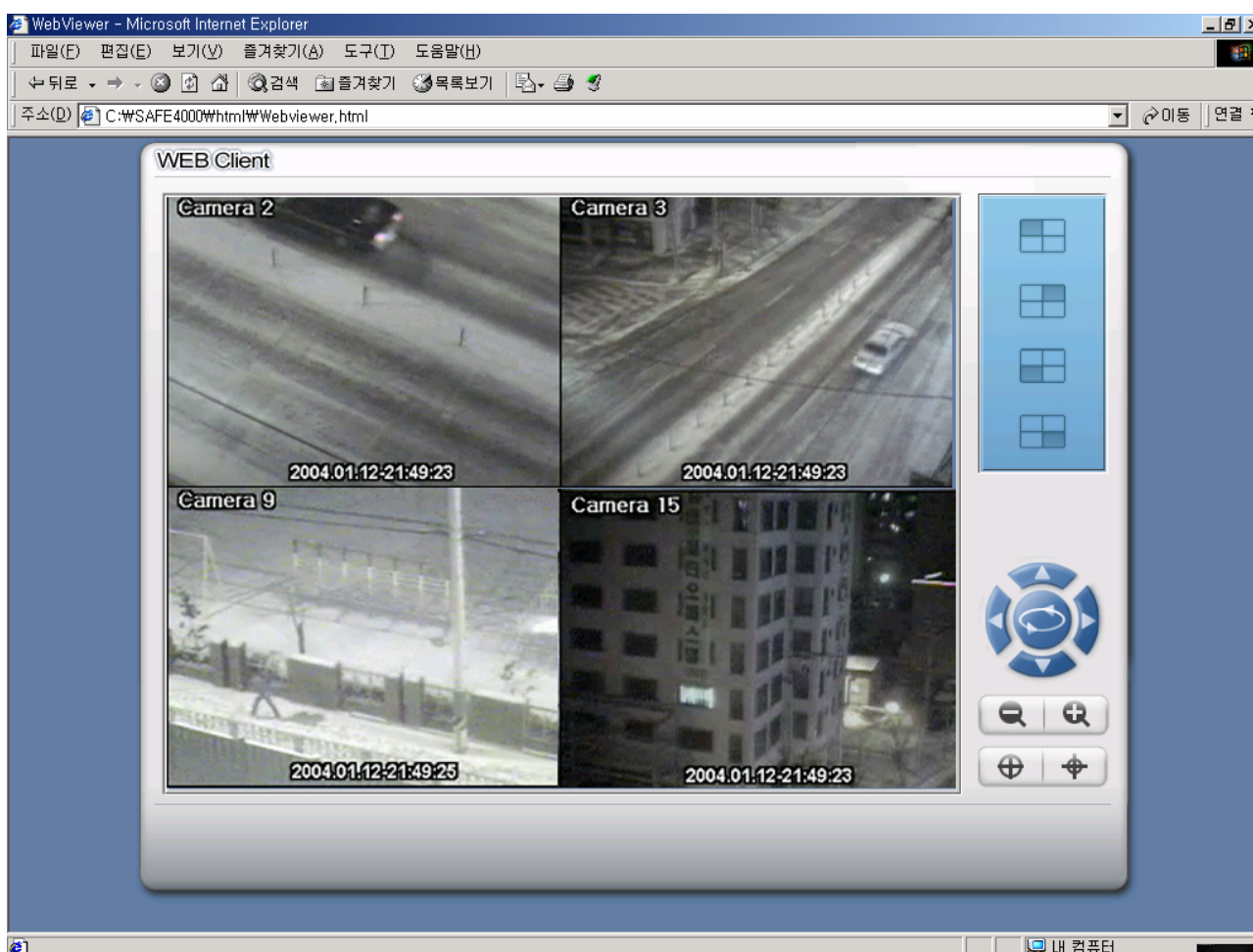

It properly works under Internet Explorer ver. 5.0 over. Type the SAFE-DVR IP in the address window of internet explorer and below window will appear.

9.2 WEB VIEWER



WEB VIEWER is very accessible because it is receiving images using a web server function. WEB VIEWER provides easy-access and control instead of search for recorded images and audio function.

WEB VIEWER provides below functions.

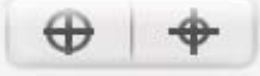
A		Show the images of camera No. 1 ~ 4.
B		Control the P/T/Z camera – Pan/Tilt/Zoom and auto panning.
C		Control the zoom of selected camera. To use this function, auto zoom lens should be installed first.
D		Control the focus of selected camera. To use this function, auto zoom lens should be installed first.

※ You should set at least 1 DVR “Guest user” in the setup mode to use Web viewer.
Remember that the default value of Guest user is 0.

10.1 TCP / IP filtering

What's 'TCP/IP filtering'?

'TCP/IP filtering' function invests all packets coming into a computer and only accept authorized of them.

(It's only for a DVR system, not for a PC.)

10.2 TCP/IP setup for 'TCP/IP filtering'

1. Right-click [My network places] icon and click [Properties].

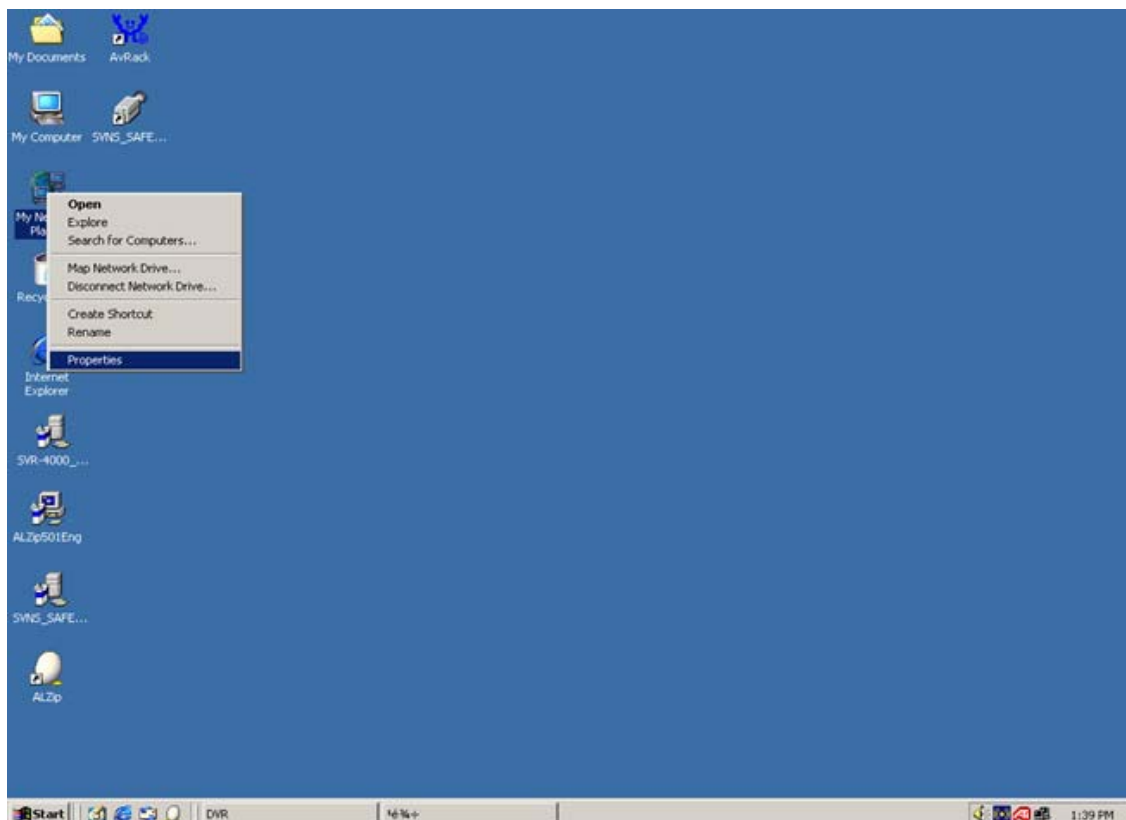

2. Right-click [Local Area Connection] or other connection to setup and click [Properties].

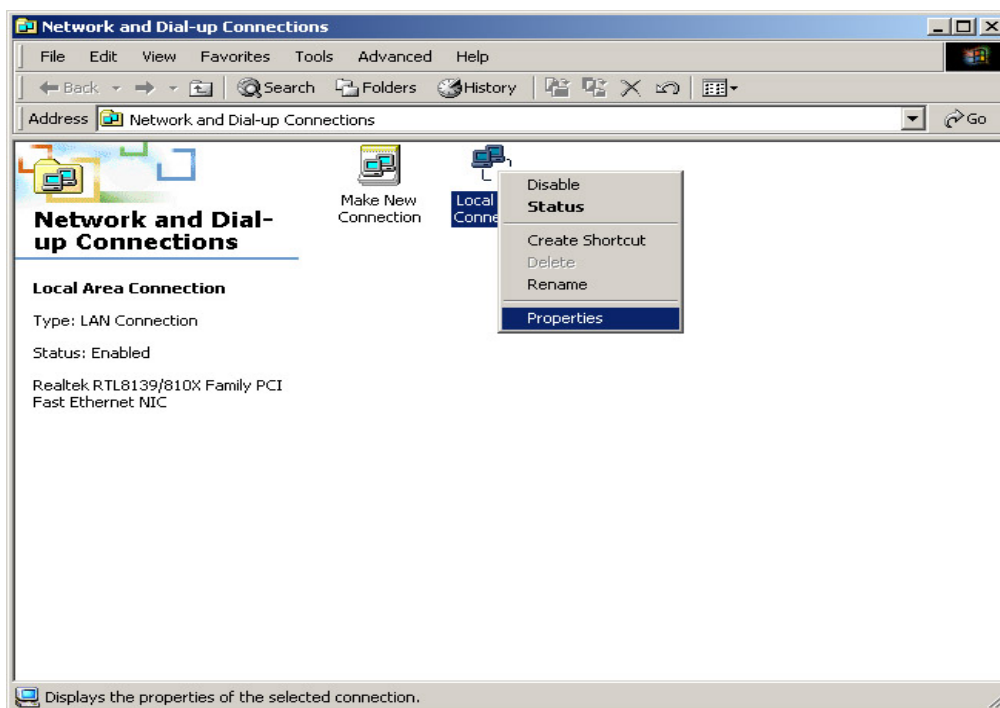

3. In [General] tab (in case you selected 'Local Area Connection') or another network tab (in case you selected another connection' in previous step), select [Internet Protocol (TCP/IP)] and click [Properties].

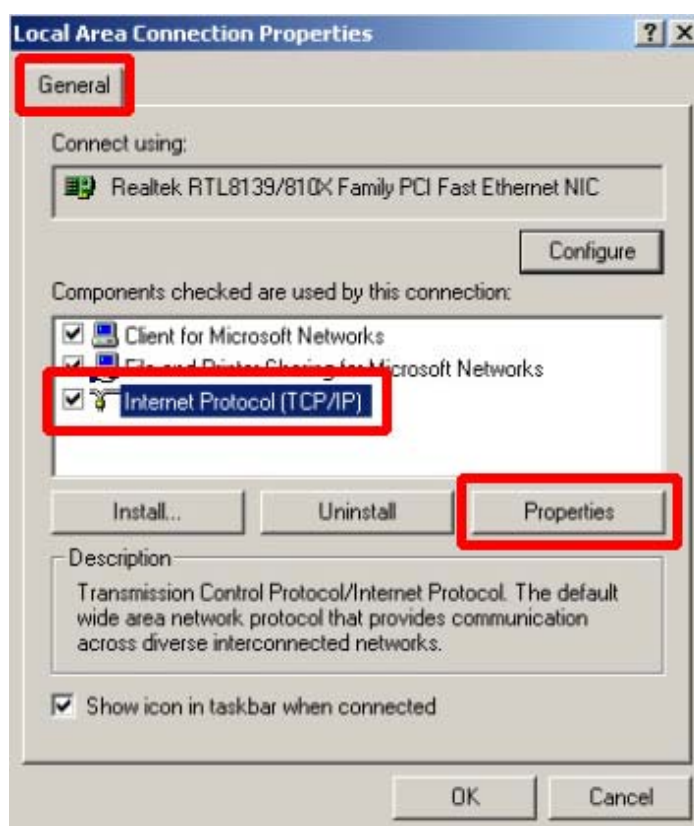

4. Click [Advanced].

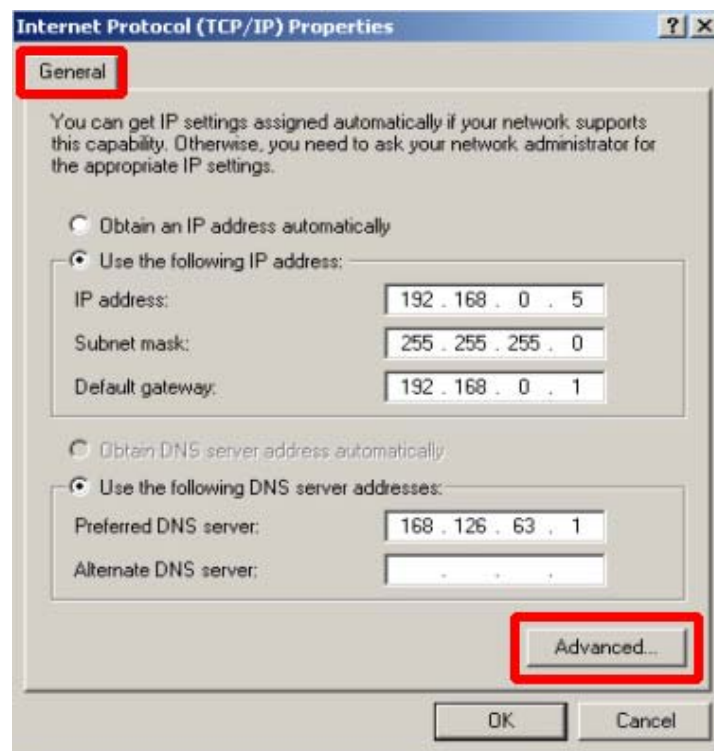

5. In [Option] tab, select [TCP/IP filtering] and click [Properties].

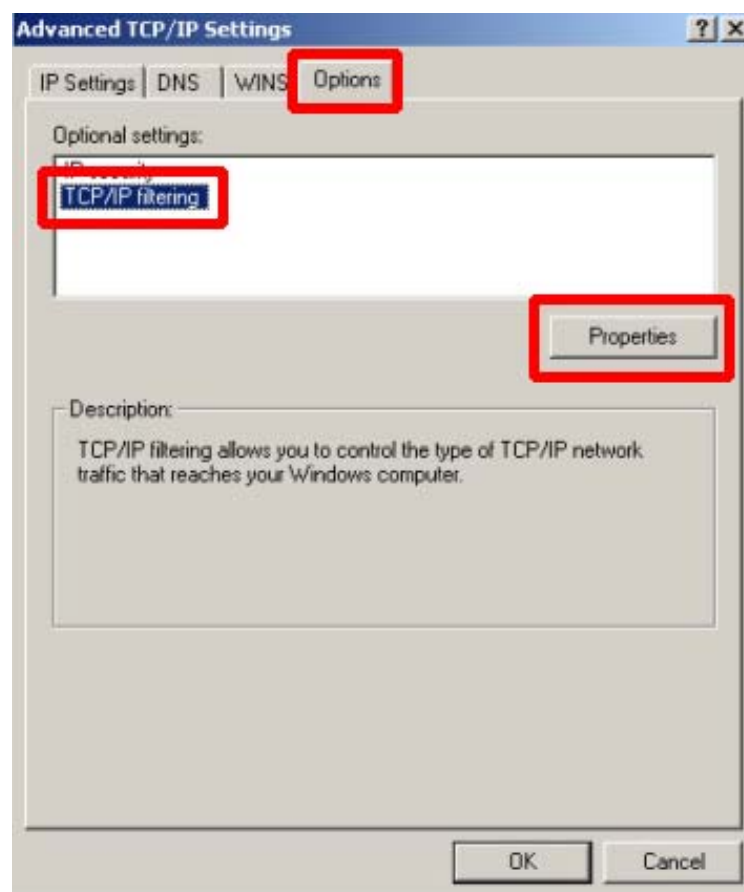

6. Follow one of below steps.

- 1) If you want to use [TCP/IP filtering] over the entire adapters, select [Enable TCP/IP Filtering (All adapters)].
- 2) If you don't want, deselect [Enable TCP/IP Filtering (All adapters)].

7. Set [TCP Ports], [UDP Ports] and [IP Protocols] for allowed traffic in accordance with the requirements of 'TCP/IP filtering'

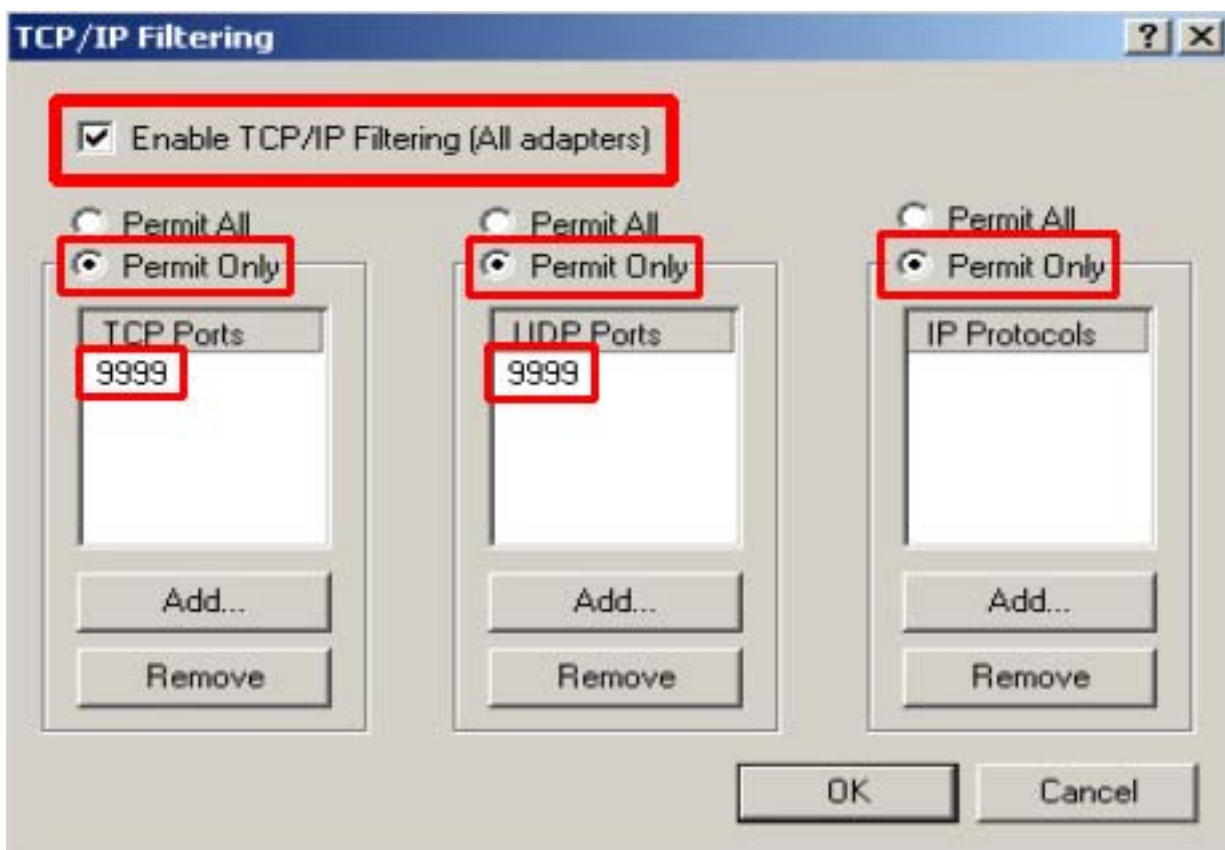

In case of SAFE-DVR, it only uses '9999', '9995' and '80' for [TCP Ports] and [UDP Ports]. So, add '9999', '9995' and '80' for [TCP Ports] and [UDP Ports], and select [Permit Only]. For [IP Protocols], just select [Permit Only] and remove all the substances.

If you do so, the access by 'Telnet' or 'FTP' is denied. Accordingly, you can set DVR systems more safely against viruses or hacking.

* Caution

This [TCP/IP filtering] is only for DVR system.

If you use [TCP/IP filtering] on your PC, it cannot access to the internet.